

# CELOKARBIDOVÉ SOUSTRUŽNICKÉ DRŽÁKY

## SCLCR 95° na destičky CCMT/CCGT/CCGX/CCMW bez IK

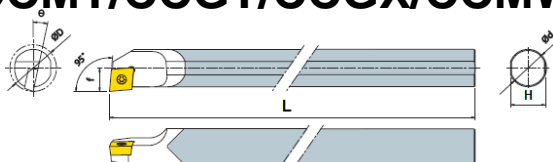

| Označení     | Rozměr (mm) |    |      |     |     | Označení destičky | CZK/ks bez DPH |
|--------------|-------------|----|------|-----|-----|-------------------|----------------|
|              | ØD (Dmin.)  | Ød | H    | L   | f   |                   |                |
| C04G-SCLCR03 | 5           | 4  | 3,7  | 90  | 2,5 | CC..0301..        | 1210           |
| C05H-SCLCR03 | 6           | 5  | 4,7  | 100 | 3   |                   | 1210           |
| C06H-SCLCR04 | 7           | 6  | 5,5  | 100 | 3,5 | CC..0401..        | 1245           |
| C08K-SCLCR06 | 10          | 8  | 7,5  | 125 | 5   | CC..0602..        | 1510           |
| C10K-SCLCR06 | 12          | 10 | 9,5  | 125 | 6   |                   | 1695           |
| C12M-SCLCR06 | 14          | 12 | 11,5 | 150 | 7   |                   | 2150           |
| C12M-SCLCR09 | 16          | 12 | 11,5 | 150 | 8   | CC..09T3..        | 2150           |
| C16R-SCLCR09 | 20          | 16 | 15   | 200 | 10  |                   | 4499           |
| C20R-SCLCR09 | 26          | 20 | 18   | 200 | 13  |                   | 5535           |

## SCLCR/L95° na destičky CCMT/CCGT/CCGX/CCMW s CHLAZENÍM

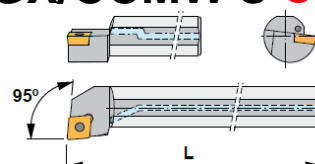
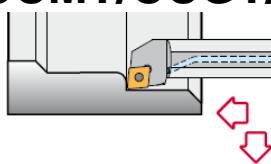

| Označení       | Rozměr (mm) |    |      |     |     | Označení destičky | CZK/ks bez DPH |
|----------------|-------------|----|------|-----|-----|-------------------|----------------|
|                | ØD (Dmin.)  | Ød | H    | L   | f   |                   |                |
| E04G-SCLCR0305 | 5           | 4  | 3,8  | 90  | 2,5 | CC..0301..        | 3695           |
| E05H-SCLCR0306 | 6           | 5  | 4,4  | 100 | 3   |                   | 3695           |
| E06J-SCLCR0307 | 7           | 6  | 5,7  | 110 | 3,5 | CC..0401..        | 3695           |
| E06H-SCLCR04   | 7           | 6  | 5,5  | 100 | 3,5 |                   | 1999           |
| E07K-SCLCR0408 | 8           | 7  | 6,4  | 120 | 4   | CC..0602..        | 3695           |
| E08K-SCLCR/L06 | 10          | 8  | 7,5  | 125 | 5   |                   | 1999           |
| E10K-SCLCR/L06 | 12          | 10 | 9,5  | 125 | 6   |                   | 1999           |
| E10M-SCLCR/L06 | 14          | 10 | 9    | 150 | 7   | CC..09T3..        | 2955           |
| E12M-SCLCR/L06 | 16          | 12 | 11,5 | 150 | 7   |                   | 2280           |
| E12Q-SCLCR/L06 | 17          | 12 | 11   | 150 | 9   |                   | 3935           |
| E16R-SCLCR/L06 | 18          | 16 | 15,5 | 200 | 10  | CC..09T3..        | 8989           |
| E12Q-SCLCR/L09 | 15          | 12 | 11,5 | 180 | 9   |                   | 5880           |
| E12M-SCLCR09   | 16          | 12 | 11,5 | 150 | 8   |                   | 2470           |
| E16R-SCLCR/L09 | 20          | 16 | 15,5 | 200 | 10  | CC..09T3..        | 4400           |
| E20S-SCLCR/L09 | 25          | 20 | 19,5 | 250 | 13  |                   | 8200           |
| E20R-SCLCR09   | 26          | 20 | 18   | 200 | 13  |                   | 6359           |
| E25T-SCLCR/L09 | 31          | 25 | 24   | 300 | 17  |                   | 22475          |

## SCLCR/L95° na destičky CCMT/CCGT/CC.. s CHLAZENÍM V SADĚ!



| Označení sady                  | Sada obsahuje:                               | Označení destičky | CZK/sada bez DPH |
|--------------------------------|--|-------------------|------------------|
| E-SCLCR SET<br>pravé provedení | E08K-SCLC.06<br>E10K-SCLC.06<br>E12M-SCLC.06 | CC..0602..        | 6400             |
| E-SCLCL SET<br>levé provedení  |  |                   | 6400             |

| Označení - destičky      | CZK/ks bez DPH |
|--------------------------|----------------|
| CCET030102 - OCEL        | 315            |
| CCET040102 - OCEL        | 315            |
| CCMT060208 - OCEL, NEREZ | 89             |
| CCMT09T308 - OCEL, NEREZ | 99             |
| CCMT120408 - OCEL, NEREZ | 129            |
| CCET030102 - HLINÍK      | 255            |
| CCET040102 - HLINÍK      | 255            |
| CCGX060208 - HLINÍK      | 109            |
| CCGX09T308 - HLINÍK      | 119            |
| CCGX120408 - HLINÍK      | 129            |

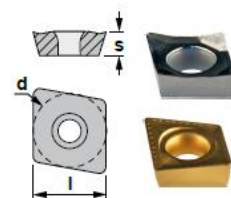

-při objednání specifikujte, na jaké použití chcete destičky = ocel, nerez, litina, hliník aj., čím lépe materiál popíšete, tím lepší variantu vám zvolíme, stejně tak si i zvolte Rádus, který potřebujete

## SCLPR/L 95° na destičky CPMT/CPGT/CPGW bez IK

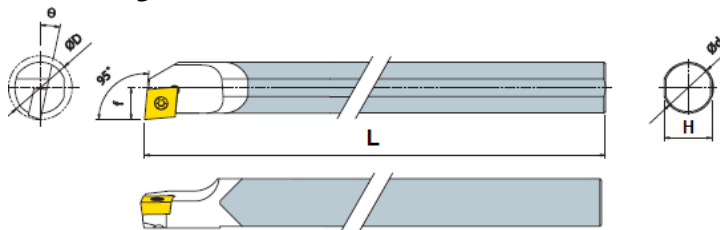

| Označení        | Rozměr (mm) |    |    |     |    | Označení destičky | CZK/ks bez DPH |
|-----------------|-------------|----|----|-----|----|-------------------|----------------|
|                 | ØD (Dmin.)  | Ød | H  | L   | f  |                   |                |
| C10M-SCLPR/L06  | 12          | 10 | 9  | 150 | 6  | CP.T0602..        | 3889           |
| C12Q-SCLPR/L06  | 16          | 12 | 11 | 180 | 8  |                   | 4430           |
| C10K-SCLPR08    | 12          | 10 | 9  | 125 | 6  | CP.T0802..        | 1695           |
| C10M-SCLPR08    | 12          | 10 | 9  | 150 | 6  |                   | 2015           |
| C12M-SCLPR08    | 15          | 12 | 11 | 150 | 7  |                   | 2150           |
| C12Q-SCLPR08    | 15          | 12 | 11 | 180 | 7  |                   | 2749           |
| C12M-SCLPR09    | 15          | 12 | 11 | 150 | 8  | CP.T0903..        | 2150           |
| C12Q-SCLPR09    | 15          | 12 | 11 | 180 | 8  |                   | 2749           |
| C16R-SCLPR09    | 20          | 16 | 15 | 200 | 10 |                   | 4499           |
| C16S-SCLPR09    | 20          | 16 | 15 | 250 | 10 |                   | 4975           |
| C20R-SCLPR09    | 25          | 20 | 18 | 200 | 13 |                   | 5535           |
| C20S-SCLPR09    | 25          | 20 | 18 | 250 | 13 |                   | 7280           |
| C16R-SCLPR/L09A | 20          | 16 | 15 | 200 | 10 | CP.T09T3..        | 5945           |
| C20S-SCLPR/L09A | 25          | 20 | 18 | 250 | 13 |                   | 7319           |

## SCLPR/L 95° na destičky CPMT/CPGT/CPGW s CHLAZENÍM

| Označení        | Rozměr (mm) |    |      |     |    | Označení destičky | CZK/ks bez DPH |
|-----------------|-------------|----|------|-----|----|-------------------|----------------|
|                 | ØD (Dmin.)  | Ød | H    | L   | f  |                   |                |
| E10K-SCLPR08    | 12          | 10 | 9    | 125 | 6  | CP.T0802..        | 1945           |
| E10M-SCLPR08    | 12          | 10 | 9    | 150 | 6  |                   | 2315           |
| E12M-SCLPR08    | 15          | 12 | 11   | 150 | 7  |                   | 2470           |
| E12Q-SCLPR08    | 15          | 12 | 11   | 180 | 7  |                   | 3159           |
| E12M-SCLPR09    | 15          | 12 | 11   | 150 | 8  | CP.T0903..        | 2470           |
| E12Q-SCLPR09    | 15          | 12 | 11   | 180 | 8  |                   | 3159           |
| E16R-SCLPR09    | 20          | 16 | 15   | 200 | 10 |                   | 5175           |
| E16S-SCLPR09    | 20          | 16 | 15   | 250 | 10 |                   | 5729           |
| E20R-SCLPR09    | 25          | 20 | 18   | 200 | 13 |                   | 6359           |
| E20S-SCLPR09    | 25          | 20 | 18   | 250 | 13 |                   | 8370           |
| E16R-SCLPR/L09A | 19          | 16 | 15.5 | 200 | 10 | CP.T09T3..        | 8989           |
| E20S-SCLPR/L09A | 24          | 20 | 19.5 | 250 | 13 |                   | 13829          |

| Označení - destičky      | CZK/ks bez DPH |
|--------------------------|----------------|
| CPMT060208 - OCEL, NEREZ | 109            |
| CPGW060204 - HLINÍK      | 119            |
| CPMT09T308 - OCEL, NEREZ | 119            |

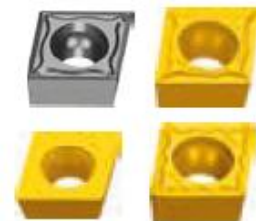

-při objednání specifikujte, na jaké použití chcete destičky = ocel, nerez, litina, hliník aj., čím lépe materiál popíšete, tím lepší variantu vám zvolíme, stejně tak si i zvolte Rádus, který potřebujete

## SDQCR 107,5° na destičky DCMT/DCGT/DCGX/DCMW bez IK

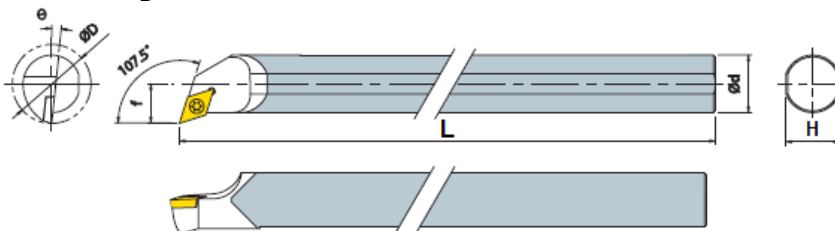

| Označení     | Rozměr (mm) |    |      |     |    | Označení destičky | CZK/ks bez DPH |
|--------------|-------------|----|------|-----|----|-------------------|----------------|
|              | ØD (Dmin.)  | Ød | H    | L   | f  |                   |                |
| C08K-SDQCR07 | 11          | 8  | 7,5  | 125 | 6  | DC..0702..        | 1510           |
| C10K-SDQCR07 | 13          | 10 | 9,5  | 125 | 7  |                   | 1695           |
| C12M-SDQCR07 | 16          | 12 | 11,5 | 150 | 9  |                   | 2150           |
| C16R-SDQCR07 | 20          | 16 | 15   | 200 | 11 |                   | 4499           |
| C16R-SDQCR11 | 20          | 16 | 15   | 200 | 11 | DC..11T3..        | 4499           |

# SDQCR/L 107,5° na destičky DCMT/DCGT/DCGX s **CHLAZENÍM**

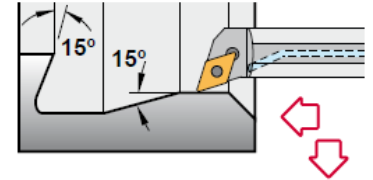
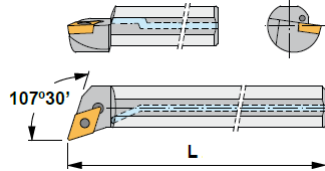
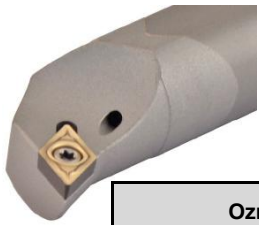

| Označení        | Rozměr (mm) |    |      |     |     | Označení destičky | CZK/ks bez DPH |
|-----------------|-------------|----|------|-----|-----|-------------------|----------------|
|                 | ØD (Dmin.)  | Ød | H    | L   | f   |                   |                |
| E08K-SDQCR07    | 11          | 8  | 7,5  | 125 | 6   | DC..0702..        | 1739           |
| E08K-SDQCR/L07A | 11          | 8  | 7,5  | 140 | 6.5 |                   | 4260           |
| E10K-SDQCR/L07  | 13          | 10 | 9,5  | 125 | 7   |                   | 1999           |
| E10M-SDQCR/L07  | 14          | 10 | 9    | 150 | 7   |                   | 2955           |
| E12M-SDQCR/L07  | 16          | 12 | 11,5 | 150 | 9   |                   | 2280           |
| E12Q-SDQCR/L07  | 17          | 12 | 11   | 180 | 9   |                   | 3935           |
| E16R-SDQCR/L07  | 20          | 16 | 15,5 | 200 | 11  |                   | 4400           |
| E16R-SDQCR/L07A | 18          | 16 | 15.5 | 200 | 10  |                   | 8989           |
| E20S-SDQCR07    | 25          | 20 | 18   | 250 | 13  |                   | 10975          |
| E20S-SDQCR/L07A | 24          | 20 | 19,5 | 250 | 13  |                   | 13829          |
| E16R-SDQCR/L11  | 20          | 16 | 15,5 | 200 | 11  |                   | 4400           |
| E16R-SDQCR/L11A | 18          | 16 | 15.5 | 200 | 10  |                   | 8989           |
| E20S-SDQCR/L11  | 25          | 20 | 19,5 | 250 | 13  |                   | 8200           |
| E25T-SDQCR11    | 31          | 25 | 23   | 300 | 17  |                   | 19769          |

# SDQCR/L 107,5° na destičky DCMT/DCG. s **CHLAZENÍM V SADĚ!**



| Označení sady                  | Sada obsahuje:               | Označení destičky | CZK/sada bez DPH |
|--------------------------------|------------------------------|-------------------|------------------|
| E-SDQCR SET<br>pravé provedení | E10K-SDQC.07<br>E12M-SDQC.07 | DC..0702..        | 4400             |
| E-SDQCL SET<br>levé provedení  |                              |                   | 4400             |

# SDUCR 93° na destičky DCMT/DCGT/DCGX/DCMW bez IK

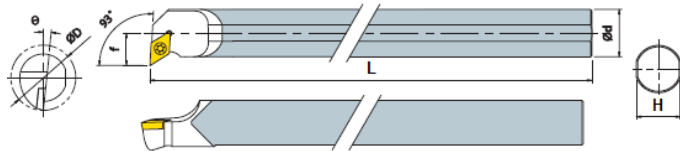

| Označení     | Rozměr (mm) |    |      |     |    | Označení destičky | CZK/ks bez DPH |
|--------------|-------------|----|------|-----|----|-------------------|----------------|
|              | ØD (Dmin.)  | Ød | H    | L   | f  |                   |                |
| C10K-SDUCR07 | 13          | 10 | 9,5  | 125 | 7  | DC..0702..        | 1695           |
| C12M-SDUCR07 | 16          | 12 | 11,5 | 150 | 9  |                   | 2150           |
| C16R-SDUCR07 | 20          | 16 | 15   | 200 | 11 |                   | 4499           |
| C16R-SDUCR11 | 20          | 16 | 15   | 200 | 11 | DC..11T3..        | 4499           |
| C20R-SDUCR11 | 25          | 20 | 18   | 200 | 13 |                   | 5535           |

# SDUCR/L 93° na destičky DCMT/DCGT/DCGX s **CHLAZENÍM**

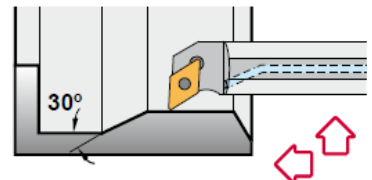
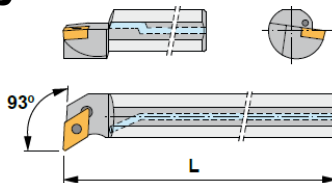

| Označení        | Rozměr (mm) |    |      |     |    | Označení destičky | CZK/ks bez DPH |
|-----------------|-------------|----|------|-----|----|-------------------|----------------|
|                 | ØD (Dmin.)  | Ød | H    | L   | f  |                   |                |
| E10K-SDUCR/L07  | 13          | 10 | 9,5  | 125 | 7  | DC..0702..        | 1999           |
| E10M-SDUCR/L07  | 14          | 10 | 9    | 150 | 7  |                   | 2955           |
| E12M-SDUCR/L07  | 16          | 12 | 11,5 | 150 | 9  |                   | 2280           |
| E12Q-SDUCR/L07  | 17          | 12 | 11   | 180 | 9  |                   | 3935           |
| E16R-SDUCR/L07  | 20          | 16 | 15,5 | 200 | 11 |                   | 4400           |
| E16R-SDUCR/L07A | 21          | 16 | 15   | 200 | 11 |                   | 6365           |
| E20S-SDUCR/L07  | 24          | 20 | 19,5 | 250 | 13 |                   | 13829          |
| E16R-SDUCR/L11  | 20          | 16 | 15,5 | 200 | 11 |                   | 4400           |
| E16R-SDUCR/L11A | 18          | 16 | 15.5 | 200 | 10 |                   | 8989           |
| E20R-SDUCR11    | 25          | 20 | 18   | 200 | 13 |                   | 6359           |
| E20S-SDUCR/L11  | 25          | 20 | 19,5 | 250 | 13 | 8200              |                |
| E25T-SDUCR11    | 32          | 25 | 23   | 300 | 17 | DC..11T3..        | 19769          |

# SDUCR/L 93° na destičky DCMT/DCG. s **CHLAZENÍM** V SADĚ!



| Označení sady                  | Sada obsahuje:               | Označení destičky | CZK/sada bez DPH |
|--------------------------------|------------------------------|-------------------|------------------|
| E-SDUCR SET<br>pravé provedení | E10K-SDUC.07<br>E12M-SDUC.07 | DC..0702..        | 4400             |
| E-SDUCL SET<br>levé provedení  |                              |                   | 4400             |

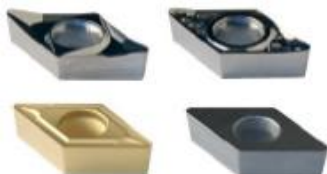

| Označení - destičky      | CZK/ks bez DPH |
|--------------------------|----------------|
| DCMT070208 - OCEL, NEREZ | 89             |
| DCMT11T308 - OCEL, NEREZ | 109            |
| DCGX070208 - HLINÍK      | 109            |
| DCGX11T308 - HLINÍK      | 119            |

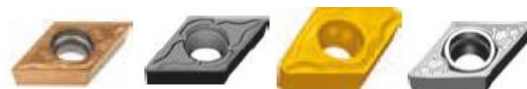

- při objednání specifikujte, na jaké použití chcete destičky = ocel, nerez, litina, hliník aj., čím lépe materiál popíšete, tím lepší variantu vám zvolíme, stejně tak si i zvolte Rádus, který potřebujete

## SDQPR/L 107,5° na destičky DPGT bez IK

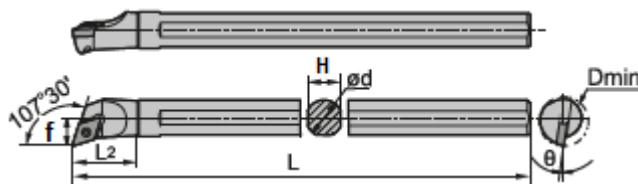

| Označení       | Rozměr (mm) |    |    |     |    | Označení destičky | CZK/ks bez DPH |
|----------------|-------------|----|----|-----|----|-------------------|----------------|
|                | ØD (Dmin.)  | Ød | H  | L   | f  |                   |                |
| C10M-SDQPR/L07 | 13          | 10 | 9  | 150 | 7  | DP.T0702..        | 3889           |
| C12Q-SDQPR/L07 | 16          | 12 | 11 | 180 | 9  |                   | 4430           |
| C16R-SDQPR/L07 | 20          | 16 | 15 | 200 | 11 |                   | 5945           |
| C16R-SDQPR/L11 | 20          | 16 | 15 | 200 | 11 | DP.T11T3..        | 5945           |
| C20S-SDQPR/L11 | 25          | 20 | 18 | 250 | 13 |                   | 7319           |

## SDUPR/L 93° na destičky DPGT bez IK

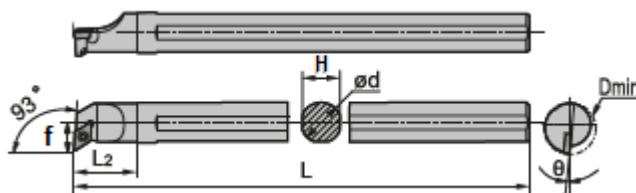

| Označení       | Rozměr (mm) |    |    |     |    | Označení destičky | CZK/ks bez DPH |
|----------------|-------------|----|----|-----|----|-------------------|----------------|
|                | ØD (Dmin.)  | Ød | H  | L   | f  |                   |                |
| C10M-SDUPR/L07 | 15          | 10 | 9  | 150 | 9  | DP.T0702..        | 3889           |
| C12Q-SDUPR/L07 | 16          | 12 | 11 | 180 | 9  |                   | 4430           |
| C16R-SDUPR/L07 | 20          | 16 | 15 | 200 | 11 |                   | 5945           |

| Označení - destičky      | CZK/ks bez DPH |
|--------------------------|----------------|
| DPGT070204 - OCEL, NEREZ | 119            |
| DPGT11T304 - OCEL, NEREZ | 135            |



## STFCR 91° na destičky TCMT/TCGT/TCGX/TCMW bez IK

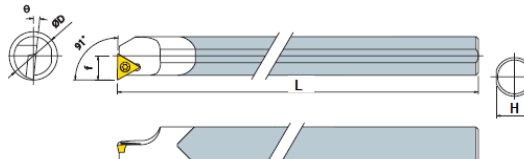

| Označení     | Rozměr (mm) |    |      |     |    | Označení destičky | CZK/ks bez DPH |
|--------------|-------------|----|------|-----|----|-------------------|----------------|
|              | ØD (Dmin.)  | Ød | H    | L   | f  |                   |                |
| C08K-STFCR09 | 10          | 8  | 7,5  | 125 | 5  | TC..0902..        | 1510           |
| C10K-STFCR11 | 12          | 10 | 9,5  | 125 | 6  | TC..1102..        | 1695           |
| C12M-STFCR11 | 16          | 12 | 11,5 | 150 | 8  |                   | 2150           |
| C16R-STFCR11 | 20          | 16 | 15   | 200 | 10 |                   | 4499           |

## STUBR 93° na destičky TBGT bez IK

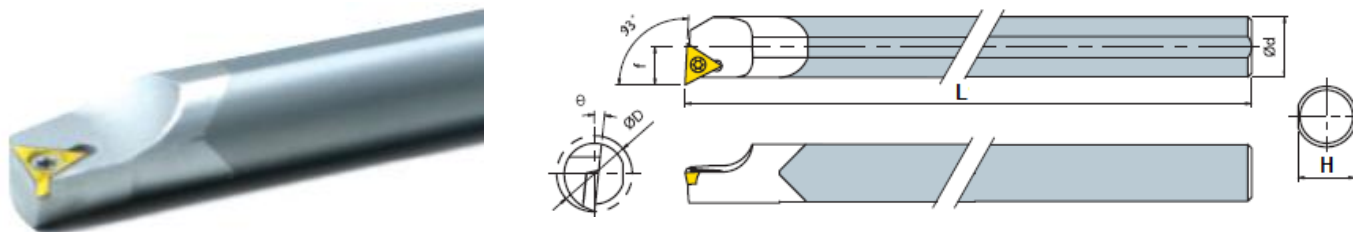

| Označení     | Rozměr (mm) |    |     |     |     | Označení destičky | CZK/ks bez DPH |
|--------------|-------------|----|-----|-----|-----|-------------------|----------------|
|              | ØD (Dmin.)  | Ød | H   | L   | f   |                   |                |
| C06H-STUBR06 | 7           | 6  | 5,5 | 100 | 3,5 | TBGT0601..        | 1245           |
| C08K-STUBR06 | 10          | 8  | 7   | 125 | 5   |                   | 1510           |
| C10K-STUBR06 | 12          | 10 | 9   | 125 | 6   |                   | 1695           |

## STUBR 93° na destičky TBGT s CHLAZENÍM

| Označení     | Rozměr (mm) |    |     |     |     | Označení destičky | CZK/ks bez DPH |
|--------------|-------------|----|-----|-----|-----|-------------------|----------------|
|              | ØD (Dmin.)  | Ød | H   | L   | f   |                   |                |
| E06H-STUBR06 | 7           | 6  | 5,5 | 100 | 3,5 | TBGT0601..        | 1479           |
| E08K-STUBR06 | 10          | 8  | 7   | 125 | 5   |                   | 1739           |
| E10K-STUBR06 | 12          | 10 | 9   | 125 | 6   |                   | 1945           |

## STFCR/L 90° na destičky TCMT/TCGT/TCGX/TCMW s CHLAZENÍM

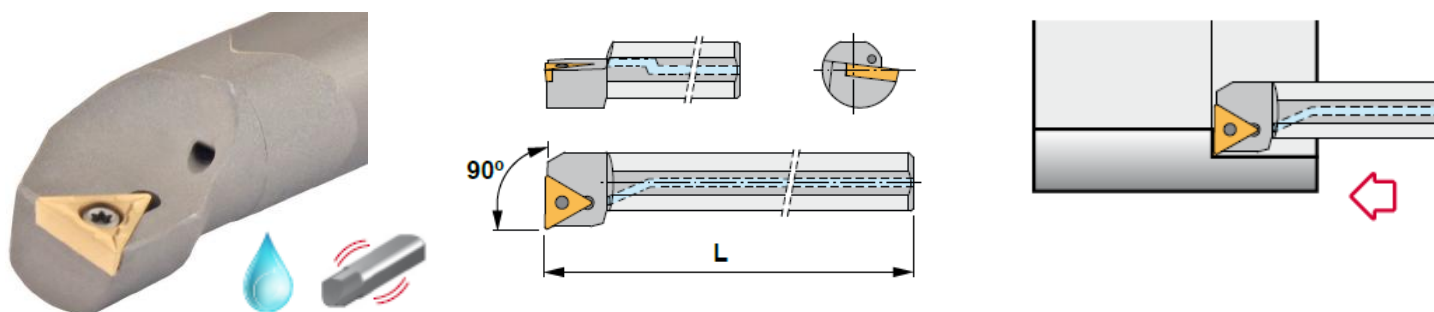

| Označení        | Rozměr (mm) |    |      |     |    | Označení destičky | CZK/ks bez DPH |
|-----------------|-------------|----|------|-----|----|-------------------|----------------|
|                 | ØD (Dmin.)  | Ød | H    | L   | f  |                   |                |
| E08K-STFCR09    | 10          | 8  | 7,5  | 125 | 5  | TC..0902..        | 1739           |
| E08K-STFCR/L09A | 11          | 8  | 7,5  | 125 | 6  |                   | 4260           |
| E10M-STFCR/L09  | 12          | 10 | 9,5  | 150 | 7  |                   | 4935           |
| E10K-STFCR11    | 12          | 10 | 9,5  | 125 | 6  | TC..1102..        | 1945           |
| E12M-STFCR11    | 16          | 12 | 11,5 | 150 | 8  |                   | 2470           |
| E12Q-STFCR/L11  | 17          | 12 | 11   | 180 | 9  |                   | 3935           |
| E16R-STFCR11    | 20          | 16 | 15   | 200 | 10 |                   | 5175           |
| E16R-STFCR/L11A | 21          | 16 | 15   | 200 | 11 |                   | 6365           |
| E20S-STFCR/L11  | 25          | 20 | 18   | 250 | 13 | TC..16T3..        | 10975          |
| E20S-STFCR/L16  | 24          | 20 | 19,5 | 250 | 13 |                   | 13829          |
| E25T-STFCR/L16  | 31          | 25 | 24   | 300 | 17 |                   | 22475          |



| Označení - destičky      | CZK/ks bez DPH |
|--------------------------|----------------|
| TCMT090208 - OCEL, NEREZ | 99             |
| TCMT110208 - OCEL, NEREZ | 109            |
| TCMT110308 - OCEL, NEREZ | 109            |
| TCMT16T308 - OCEL, NEREZ | 119            |
| TCGX090208 - HLIŇÍK      | 109            |
| TCGX110208 - HLIŇÍK      | 119            |
| TCGX16T308 - HLIŇÍK      | 129            |

-při objednání specifikujte, na jaké použití chcete destičky = ocel, nerez, litina, hliník aj., čím lépe materiál popíšete, tím lepší variantu vám zvolíme, stejně tak si i zvolte Rádus, který potřebujete

## STFPR 91° na destičky TPGT bez IK

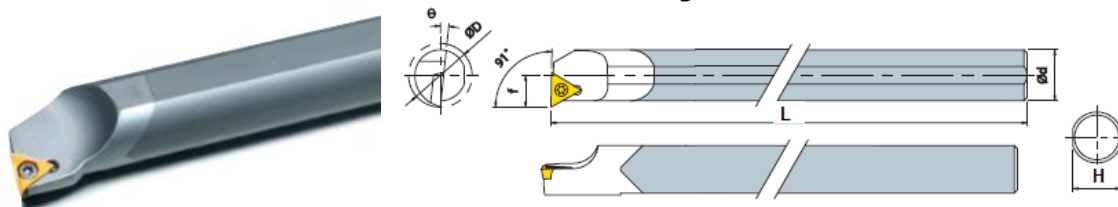

| Označení     | Rozměr (mm) |    |      |     |      | Označení destičky | CZK/ks bez DPH |
|--------------|-------------|----|------|-----|------|-------------------|----------------|
|              | ØD (Dmin.)  | Ød | H    | L   | f    |                   |                |
| C08K-STFPR08 | 10          | 8  | 7,5  | 125 | 5    | TPGT0802..        | 1510           |
| C10K-STFPR09 | 12          | 10 | 9,5  | 125 | 6    | TPGT0902..        | 1695           |
| C10K-STFPR11 | 12          | 10 | 9,5  | 125 | 6    | TPGT1103..        | 1695           |
| C12M-STFPR11 | 16          | 12 | 11,5 | 150 | 8    |                   | 2150           |
| C16R-STFPR11 | 20          | 16 | 15   | 200 | 10   |                   | 4499           |
| C16R-STFPR16 | 25          | 20 | 18   | 200 | 12,5 | TPGT1604..        | 4499           |

## STFPR/L 90° na destičky TPGT s CHLAZENÍM

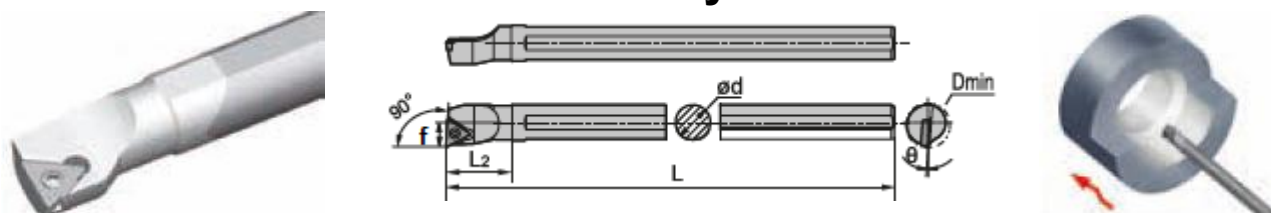

| Označení        | Rozměr (mm) |    |      |     |      | Označení destičky | CZK/ks bez DPH |
|-----------------|-------------|----|------|-----|------|-------------------|----------------|
|                 | ØD (Dmin.)  | Ød | H    | L   | f    |                   |                |
| E08K-STFPR08    | 10          | 8  | 7,5  | 125 | 5    | TPGT0802..        | 1739           |
| E10K-STFPR09    | 12          | 10 | 9,5  | 125 | 6    | TPGT0902..        | 1945           |
| E10K-STFPR11    | 12          | 10 | 9,5  | 125 | 6    | TPGT1102..        | 1945           |
| E12M-STFPR11    | 16          | 12 | 11,5 | 150 | 8    |                   | 2470           |
| E16R-STFPR11    | 20          | 16 | 15   | 200 | 10   |                   | 5170           |
| E10M-STFPR/L11  | 12          | 10 | 9,5  | 150 | 6    | TPGT1103..        | 4935           |
| E12Q-STFPR/L11  | 15          | 12 | 11,5 | 180 | 8    |                   | 5880           |
| E16R-STFPR/L11A | 19          | 16 | 15,5 | 200 | 10   |                   | 8989           |
| E20S-STFPR/L11  | 24          | 20 | 19   | 250 | 13   |                   | 13829          |
| E16R-STFPR16    | 25          | 20 | 18   | 200 | 12,5 | TPGT1604..        | 5175           |

## STUPR/L 93° na destičky TPGT bez IK

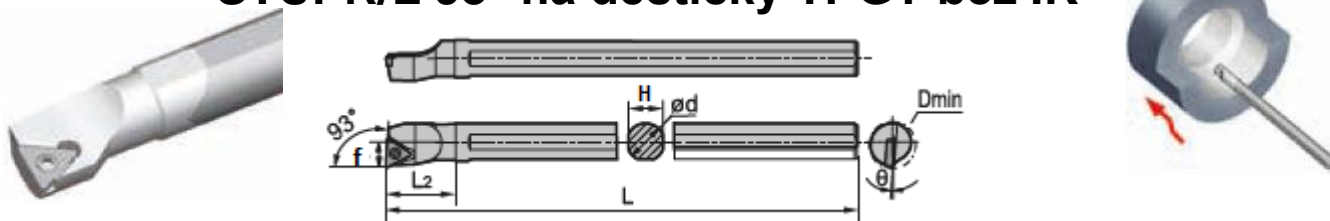

| Označení       | Rozměr (mm) |    |    |     |    | Označení destičky | CZK/ks bez DPH |      |
|----------------|-------------|----|----|-----|----|-------------------|----------------|------|
|                | ØD (Dmin.)  | Ød | H  | L   | f  |                   |                |      |
| C08K-STUPR08   | 10          | 8  | 7  | 125 | 5  | TPG.0802..        | 1510           |      |
| C10M-STUPR/L09 | 12          | 10 | 9  | 150 | 6  | TPG.0902..        | 3889           |      |
| C12Q-STUPR/L09 | 16          | 12 | 11 | 180 | 8  |                   | 4430           |      |
| C10K-STUPR11   | 12          | 10 | 9  | 125 | 6  | TPG.1103..        | 1695           |      |
| C10M-STUPR11   | 12          | 10 | 9  | 150 | 6  |                   | 2015           |      |
| C12M-STUPR11   | 15          | 12 | 11 | 150 | 8  |                   | 2150           |      |
| C12Q-STUPR11   | 15          | 12 | 11 | 180 | 8  |                   | 2749           |      |
| C16R-STUPR11   | 20          | 16 | 15 | 200 | 10 |                   | 4499           |      |
| C16S-STUPR11   | 20          | 16 | 15 | 250 | 10 |                   | 4975           |      |
| C20R-STUPR11   | 25          | 20 | 18 | 200 | 13 |                   | 5535           |      |
| C20S-STUPR11   | 25          | 20 | 18 | 250 | 10 |                   | 7280           |      |
| C20R-STUPR16   | 25          | 20 | 18 | 200 | 13 |                   | TPG.1604..     | 5535 |
| C20S-STUPR16   | 25          | 20 | 18 | 250 | 13 |                   |                | 7280 |
| C25T-STUPR16   | 32          | 25 | 23 | 300 | 17 | 13235             |                |      |

# STUPR 93° na destičky TPGT s **CHLAZENÍM**

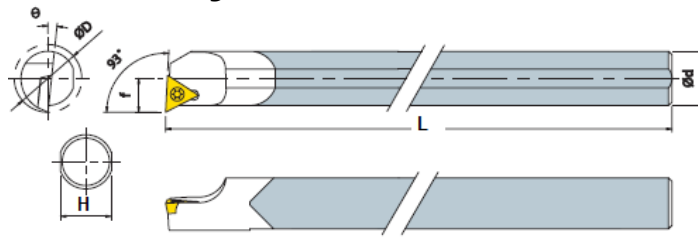

| Označení     | Rozměr (mm) |    |    |     |    | Označení destičky | CZK/ks bez DPH |
|--------------|-------------|----|----|-----|----|-------------------|----------------|
|              | ØD (Dmin.)  | Ød | H  | L   | f  |                   |                |
| E08K-STUPR08 | 10          | 8  | 7  | 125 | 5  | TPGT0802..        | 1739           |
| E10K-STUPR11 | 12          | 10 | 9  | 125 | 6  | TPGT1103..        | 1945           |
| E10M-STUPR11 | 12          | 10 | 9  | 150 | 6  |                   | 2315           |
| E12M-STUPR11 | 15          | 12 | 11 | 150 | 8  |                   | 2470           |
| E12Q-STUPR11 | 15          | 12 | 11 | 180 | 8  |                   | 3159           |
| E16R-STUPR11 | 20          | 16 | 15 | 200 | 10 |                   | 5170           |
| E16S-STUPR11 | 20          | 16 | 15 | 250 | 10 |                   | 5729           |
| E20R-STUPR11 | 25          | 20 | 18 | 200 | 13 |                   | 6359           |
| E20S-STUPR11 | 25          | 20 | 18 | 250 | 10 |                   | 8370           |
| E20R-STUPR16 | 25          | 20 | 18 | 200 | 13 |                   | 6359           |
| E20S-STUPR16 | 25          | 20 | 18 | 250 | 13 |                   | 8370           |
| E25T-STUPR16 | 32          | 25 | 23 | 300 | 17 | TPGT1604..        | 15209          |

| Označení - destičky      | CZK/ks bez DPH |
|--------------------------|----------------|
| TPGT090204 - OCEL, NEREZ | 109            |
| TPGT110304 - OCEL, NEREZ | 120            |



-při objednání specifikujte, na jaké použití chcete destičky = ocel, nerez, litina, hliník aj., čím lépe materiál popíšete, tím lepší variantu vám zvolíme, stejně tak si i zvolte Rádus, který potřebujete

## SVQCR/L 107,5° na destičky VCMT/VCGT/VCGX/VCMW bez IK

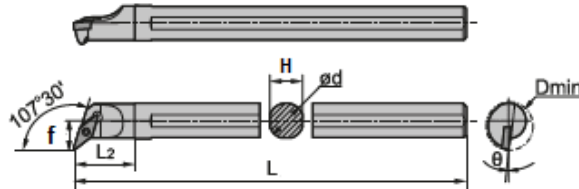

| Označení       | Rozměr (mm) |    |    |     |    | Označení destičky | CZK/ks bez DPH |
|----------------|-------------|----|----|-----|----|-------------------|----------------|
|                | ØD (Dmin.)  | Ød | H  | L   | f  |                   |                |
| C16R-SVQCR/L11 | 22          | 16 | 15 | 200 | 13 | VC..1103..        | 5945           |
| C20S-SVQCR/L11 | 26          | 20 | 18 | 250 | 15 |                   | 7319           |

## SVUCR/L 93° na destičky VCMT/VCGT/VCGX/VCMW bez IK

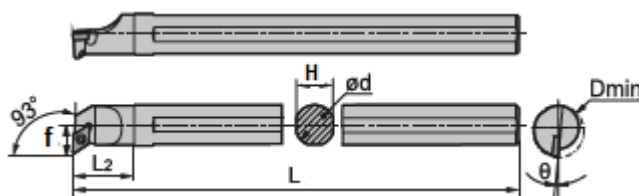

| Označení       | Rozměr (mm) |    |    |     |    | Označení destičky | CZK/ks bez DPH |
|----------------|-------------|----|----|-----|----|-------------------|----------------|
|                | ØD (Dmin.)  | Ød | H  | L   | f  |                   |                |
| C16R-SVUCR/L11 | 24          | 16 | 15 | 200 | 15 | VC..1103..        | 5945           |
| C20S-SVUCR/L11 | 28          | 20 | 18 | 250 | 17 |                   | 7319           |

# SVUCR/L 93° na destičky VCMT/VCGT/VCGX s **CHLAZENÍM**

| Označení       | Rozměr (mm) |    |    |     |      | Označení destičky | CZK/ks bez DPH |
|----------------|-------------|----|----|-----|------|-------------------|----------------|
|                | ØD (Dmin.)  | Ød | H  | L   | f    |                   |                |
| E16R-SVUCR/L11 | 22          | 16 | 15 | 200 | 13   | VC..1103..        | 8989           |
| E20S-SVUCR/L11 | 27          | 20 | 18 | 250 | 13   |                   | 13829          |
| E25T-SVUCR/L16 | 35          | 25 | 23 | 300 | 20.5 | VC..1604..        | 22475          |

| Označení - destičky      | CZK/ks bez DPH |
|--------------------------|----------------|
| VCMT110308 - OCEL, NEREZ | 129            |
| VCMT130304 - OCEL, NEREZ | 185            |
| VCMT160408 - OCEL, NEREZ | 150            |
| VCGX110308 - HLINÍK      | 135            |
| VCGT130304 - HLINÍK      | 195            |
| VCGX160408 - HLINÍK      | 149            |
| VCGX220530 - HLINÍK      | 209            |



-při objednání specifikujte, na jaké použití chcete destičky = ocel, nerez, litina, hliník aj., čím lépe materiál popíšete, tím lepší variantu vám zvolíme, stejně tak si i zvolte Rádus, který potřebujete

## SWUBR 95° na destičky WBMT bez IK

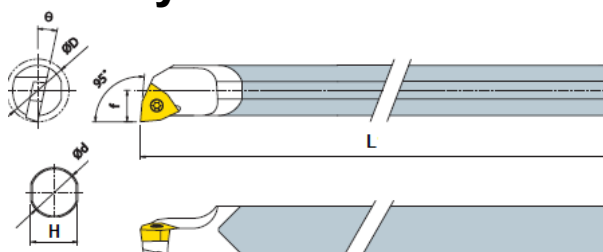

| Označení     | Rozměr (mm) |    |     |     |     | Označení destičky | CZK/ks bez DPH |
|--------------|-------------|----|-----|-----|-----|-------------------|----------------|
|              | ØD (Dmin.)  | Ød | H   | L   | f   |                   |                |
| C05H-SWUBR06 | 6           | 5  | 4,7 | 100 | 3   | WBMT0601..        | 1205           |
| C06H-SWUBR06 | 7           | 6  | 5,5 | 100 | 3,5 |                   | 1245           |
| C08K-SWUBR08 | 10          | 8  | 7,5 | 125 | 5   | WBMT0802..        | 1510           |

## SWUBR 95° na destičky WBMT s **CHLAZENÍM**

| Označení     | Rozměr (mm) |    |     |     |     | Označení destičky | CZK/ks bez DPH |
|--------------|-------------|----|-----|-----|-----|-------------------|----------------|
|              | ØD (Dmin.)  | Ød | H   | L   | f   |                   |                |
| E06H-SWUBR06 | 7           | 6  | 5,5 | 100 | 3,5 | WBMT0601..        | 1479           |
| E08K-SWUBR08 | 10          | 8  | 7,5 | 125 | 5   | WBMT0802..        | 1739           |

---

# **A**LICON s.r.o. Váš partner v třískovém obrábění

Vápencová 547/4, 147 00 Praha 4, IČ: 28179706, DIČ: CZ28179706  
 Tel: +420774317627, Fax: +420227203615, e-mail: [info@alicon.cz](mailto:info@alicon.cz), [www.alicontool.cz](http://www.alicontool.cz)