

VNĚJŠÍ SOUSTRUŽNICKÉ DRŽÁKY "P" UPNUTÍ

PCBNR/L 75° na destičky CNMG/CNMA/CNMM

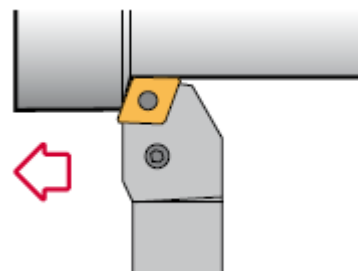
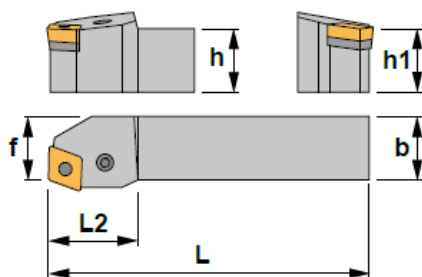

Označení	Rozměr (mm)				Označení destičky	CZK/ks bez DPH
	h	b	L	f		
PCBNR/L2020K12	20	20	125	17	CNM.1204..	1020
PCBNR/L2020K12K	20	20	125	17,5		999
PCBNR/L2525M12	25	25	150	22		1100
PCBNR/L2525M12K	25	25	150	22,5		999
PCBNR/L3225P12	32	25	170	22		1529
PCBNR/L3232P12	32	32	170	27	CNM.1606..	1469
PCBNR/L2525M16	25	25	150	22		1100
PCBNR/L3225P16	32	25	170	22	CNM.1906..	1529
PCBNR/L3232P16	32	32	170	27		1409
PCBNR/L3225P19	32	25	170	22	CNM.2507..	1529
PCBNR/L3232P19	32	32	170	27		1409
PCBNR/L4040S19	40	40	250	37	CNM.2509..	1999
PCBNR/L4040S2507	40	40	250	35		2969
PCBNR/L4040S2509	40	40	250	35	CNM.2509..	2969
PCBNR/L4040S25	40	40	250	41		2020
PCBNR/L5050T25	50	50	300	47		3400

PCKNR/L 75° na destičky CNMG/CNMA/CNMM

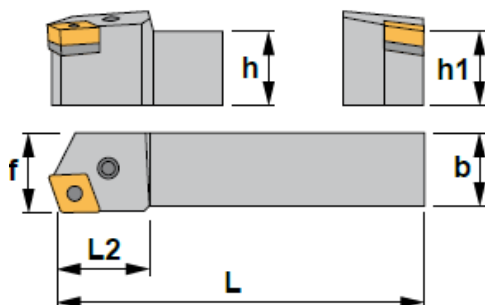

Označení	Rozměr (mm)				Označení destičky	CZK/ks bez DPH
	h	b	L	f		
PCKNR/L2020K12	20	20	125	25	CNM.1204..	999
PCKNR/L2525M12	25	25	150	32		999
PCKNR/L3225P12	32	25	170	32		1529
PCKNR/L3232P12	32	32	170	40		1409
PCKNR/L2525M16	25	25	150	32	CNM.1606..	1099
PCKNR/L3232P19	32	32	170	40	CNM.1906..	1699
PCKNR/L4040S19	40	40	250	50		1999
PCKNR/L4040S25	40	40	250	50	CNM.2509..	2449
PCKNR/L5050T25	50	50	300	60		3775

PCLNR/L 95° na destičky CNMG/CNMA/CNMM

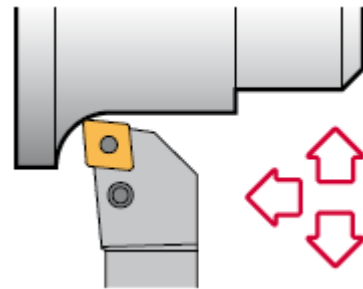
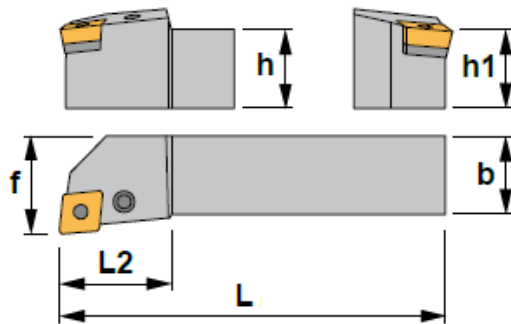

Označení	Rozměr (mm)				Označení destičky	CZK/ks bez DPH
	h	b	L	f		
PCLNR/L1616H09	16	16	100	20	CNM.0903..	969
PCLNR/L2020K09	20	20	125	25		1020
PCLNR/L2525M09	25	25	150	32		1020
PCLNR/L1616H12	16	16	100	20	CNM.1204..	950
PCLNR/L2020K12	20	20	125	25		950
PCLNR/L2525M12	25	25	150	32		999
PCLNR/L3225P12	32	25	170	32		1120
PCLNR/L3232P12	32	32	170	40	CNM.1606..	1060
PCLNR/L2525M16	25	25	150	32		1099
PCLNR/L3225P16	32	25	170	32		1529
PCLNR/L3232P16	32	32	170	40	CNM.1906..	1409
PCLNR/L4040S16	40	40	250	50		2449
PCLNR/L2525M19	25	25	150	32		1100
PCLNR/L3225P19	32	25	170	32		1529
PCLNR/L3232P19	32	32	170	40	CNM.2507..	1409
PCLNR/L4040S19	40	40	250	50		1999
PCLNR/L5050T19	50	50	300	60		3775
PCLNR/L4040S2507	40	40	250	50	CNM.2509..	2969
PCLNR/L4040S2509	40	40	250	50		2969
PCLNR/L5050T25	50	50	300	60		3400

PCFNR/L 90° na destičky CNMG/CNMA/CNMM

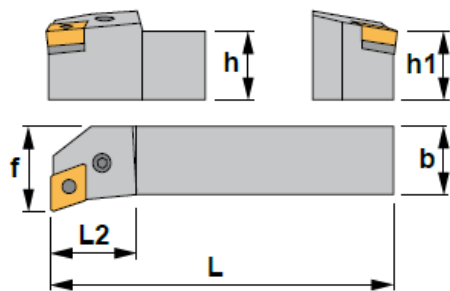
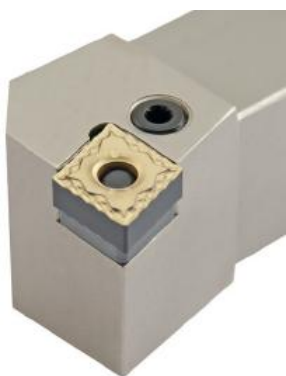

Označení	Rozměr (mm)				Označení destičky	CZK/ks bez DPH
	h	b	L	f		
PCFNR/L2525M12	25	25	150	32	CNM.1204..	1409
PCFNR/L2525M16	25	25	150	32	CNM.1606..	1409
PCFNR/L3225P16	32	25	170	32		1529
PCFNR/L3232P16	32	32	170	40		1819
PCFNR/L3225P19	32	25	170	32	CNM.1906..	1529
PCFNR/L3232P19	32	32	170	40		1819
PCFNR/L4040S19	40	40	250	50		2449

PCMNN 50° na destičky CNMG/CNMA/CNMM

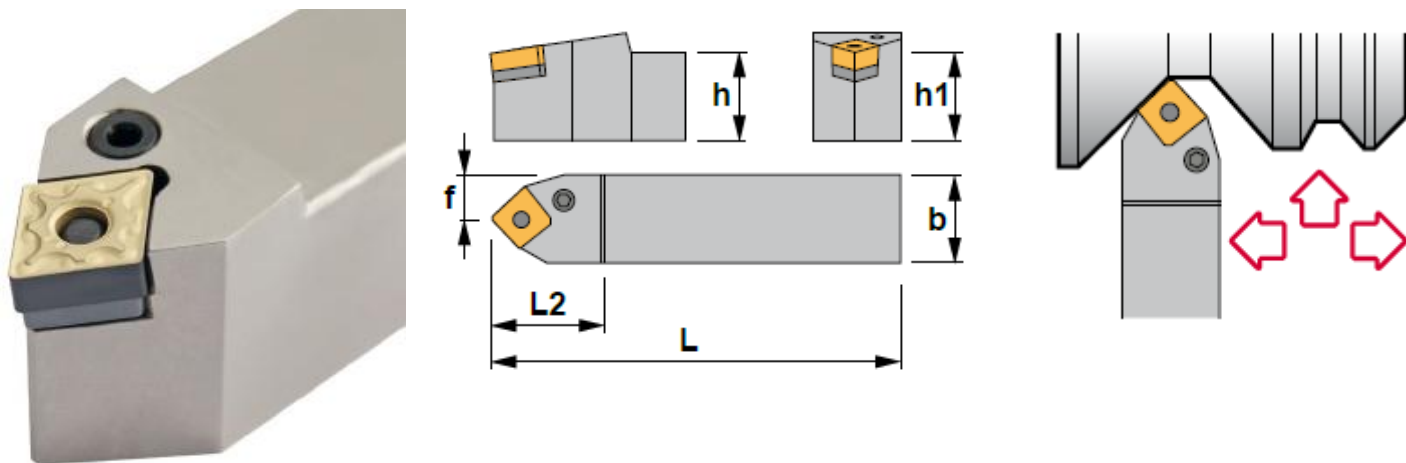

Označení	Rozměr (mm)				Označení destičky	CZK/ks bez DPH
	h	b	L	f		
PCMNN2020K12	20	20	125	10	CNM.1204..	1165
PCMNN2525M12	25	25	150	12,5		1225
PCMNN3225P12	32	25	170	12,5		1529
PCMNN3232P19	32	32	170	16	CNM.1906..	1575
PCMNN4040S19	40	40	250	20		2449

PCSNR/L 45° na destičky CNMG/CNMA/CNMM

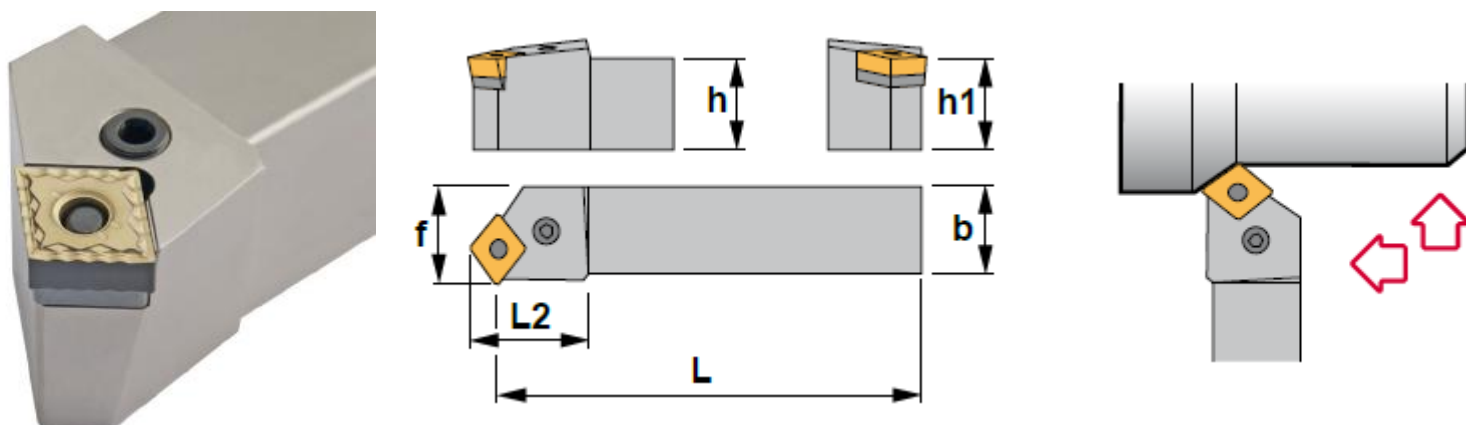

Označení	Rozměr (mm)				Označení destičky	CZK/ks bez DPH
	h	b	L	f		
PCSNR/L2020K12	20	20	125	25	CNM.1204..	1325
PCSNR/L2525M12	25	25	150	32		1409
PCSNR/L2525M16	25	25	150	32	CNM.1606..	1409
PCSNR/L3225P16	32	25	170	32		1529
PCSNR/L3232P16	32	32	170	40		1819
PCSNR/L3225P19	32	25	170	32	CNM.1906..	1529
PCSNR/L3232P19	32	32	170	40		1819
PCSNR/L4040S19	40	40	250	50		2449

Označení destičky	CZK/ks bez DPH
CNMG090308	99
CNMG120408	119
CNMG160608	199
CNMG190608	259
CNMM250724	525
CNMG250924	579



při objednání specifikujte na jaké použití chcete destičky= ocel, nerez, litina, aj., čím lépe materiál popíšete tím lepší variantu vám zvolíme
také pokud by jste raději jiný RÁDIUS či typ CNMA/CNMM napište si to do požadavků

PDJNR/L 93° na destičky DNMG/DNMA/DNMM/DNMX

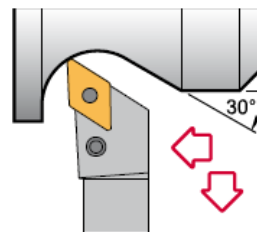
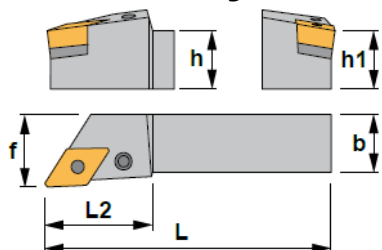

Označení	Rozměr (mm)				Označení destičky	CZK/ks bez DPH
	h	b	L	f		
PDJNR/L1616H11	16	16	100	20	DNM.1104..	950
PDJNR/L2020K11	20	20	125	25		950
PDJNR/L2525M11	25	25	150	32		999
PDJNR/L3225P11	32	25	170	32		1529
PDJNR/L2020K1504	20	20	125	25	DNM.1504..	980
PDJNR/L2525M1504	25	25	150	32		1060
PDJNR/L3232P1504	32	32	170	40		1380
PDJNR/L2020K15	20	20	125	25	DNM.1506..	950
PDJNR/L2525M15	25	25	150	32		999
PDJNR/L3225P15	32	25	170	32		1529
PDJNR/L3232P15	32	32	170	40		1225
PDJNR/L4025R15	40	25	200	32		2449
PDJNR/L5032S15	50	32	250	40		3775

PDNN R/L/N 63° na destičky DNMG/DNMA/DNMM/DNMX

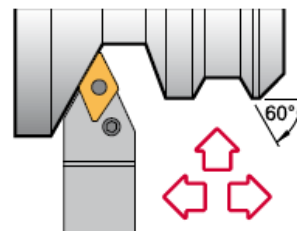
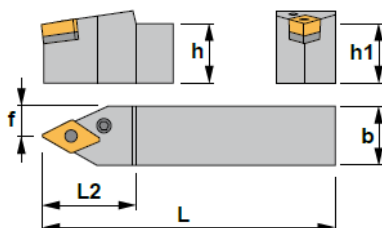

Označení	Rozměr (mm)				Označení destičky	CZK/ks bez DPH
	h	b	L	f		
PDNNR/L2020K1504	20	20	125	8	DNM.1504..	1119
PDNNR/L2525M1504	25	25	150	12,5		1119
PDNNR/L3232P1504	32	32	170	16		1469
PDNNR/L2020K15A	20	20	125	8	DNM.1506..	1119
PDNNR/L2020K15	20	20	125	10		1325
PDNNR/L2020K15C	20	20	125	16		999
PDNNR/L2525M15	25	25	150	12,5		1119
PDNNR/L2525M15A	25	25	150	18,5		1099
PDNNR/L3225P15	32	25	170	12,5		1529
PDNNR/L3232P15	32	32	170	16		1469
PDNNR/L3232P15A	32	32	170	23,4		1500
PDNNR/L4025S15	40	25	250	12,5		2449
PDNNR/L5032S15	50	32	250	16		3775

Označení	Rozměr (mm)				Označení destičky	CZK/ks bez DPH
	h	b	L	f		
PDNNN2020K11	20	20	125	10	DNM.1104..	950
PDNNN2525M11	25	25	150	12,5		999
PDNNN2020K1504	20	20	125	10	DNM.1504..	980
PDNNN2525M1504	25	25	150	12,5		1060
PDNNN2020K15	20	20	125	10	DNM.1506..	950
PDNNN2525M15	25	25	150	12,5		999
PDNNN3225P15	32	25	170	12,5		1529
PDNNN3232P15	32	32	170	16		1819
PDNNN4025S15	40	25	250	12,5		2449
PDNNN5032S15	50	32	250	16		3775

Označení destičky	CZK/ks bez DPH
DNMG110408	129
DNMG150408	155
DNMG150608	169

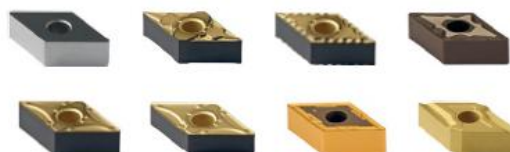

- při objednání specifikujte, na jaké použití destičky chcete = ocel, nerez, litina, aj., čím lépe materiál popíšete, tím lepší variantu vám zvolíme, také pokud by jste raději jiný RÁDIUS či typ DNMA/DNMM/DNMX napište si to do požadavků

PRGCR/L na destičky RCMT/RCMX/RCGT

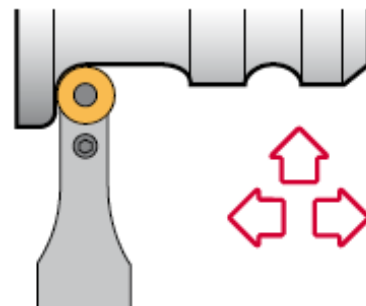
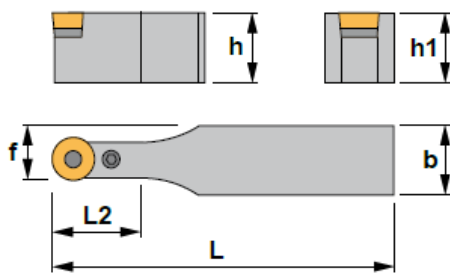

Označení	Rozměr (mm)				Označení destičky	CZK/ks bez DPH
	h	b	L	f		
PRDCN2020K10	20	20	125	15,0	RCM.1003MO	1325
PRDCN2020K10K	20	20	125	10,0		999
PRDCN2020M10	20	20	150	10,0		999
PRDCN2525M10	25	25	150	18,5		1409
PRDCN2525M10K	25	25	150	12,5		999
PRDCN3225P10	32	25	170	18,5		1529
PRDCN2020K12K	20	20	125	10,0	RCM.1204MO	999
PRDCN2020K12	20	20	125	16,0		1325
PRDCN2525M12K	25	25	150	12,5		999
PRDCN2525M12	25	25	150	18,5		1409
PRDCN3225P12	32	25	170	18,5		1529
PRDCN3232P12	32	32	170	22		1819
PRDCN4025S12	40	25	250	18,5	2449	
PRDCN2525Q16	25	25	180	12,5	RCM.1606MO	1099
PRDCN3225P16	32	25	170	20,5		1529
PRDCN3232P16	32	32	170	24		1819
PRDCN3232Q16	32	32	180	16		1409
PRDCN3232Q20	32	32	180	16	RCM.2006MO	1479
PRDCN3232P20	32	32	170	26		1819
PRDCN4040S20	40	40	250	30	2449	
PRDCN4040S25K	40	40	250	20	RCM.2507MO	1750
PRDCN4040S25	40	40	250	32,5		2449
PRDCN4040U25	40	40	350	32,5		2449
PRDCN5050U25	50	50	350	37,5		3775
PRDCN5050V32	50	50	400	41	RCM.3209MO	3775

PRGCR/L na destičky RCMT/RCMX/RCGT

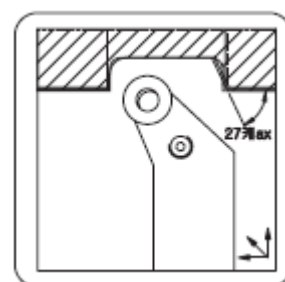
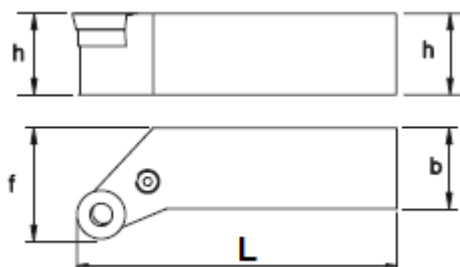

Označení	Rozměr (mm)				Označení destičky	CZK/ks bez DPH
	h	b	L	f		
PRGCR/L2020K10	20	20	150	25	RCM.1003MO	999
PRGCR/L2525M10	25	25	150	32		999
PRGCR/L2020K12	20	20	125	25	RCM.1204MO	999
PRGCR/L2525M12	25	25	150	32		999
PRGCR/L2525M16	25	25	150	32	RCM.1606MO	1099
PRGCR/L3232P16	32	32	170	40		1409
PRGCR/L3232P20	32	32	170	40	RCM.2006MO	1479

PRSCR/L na destičky RCMT/RCMX/RCGT

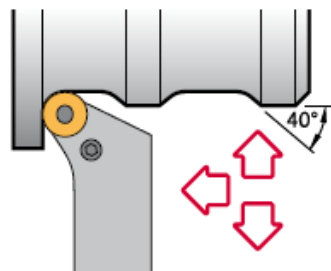
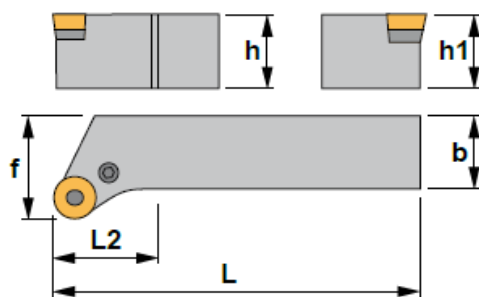

Označení	Rozměr (mm)				Označení destičky	CZK/ks bez DPH
	h	b	L	f		
PRSCR/L2020K10	20	20	125	25	RCM.1003MO	1325
PRSCR/L2525M10	25	25	150	32		1409
PRSCR/L3225P10	32	25	170	32		1529
PRSCR/L2020K12	20	20	125	25	RCM.1204MO	1325
PRSCR/L2525M12	25	25	150	32		1409
PRSCR/L3225P12	32	25	170	32		1529
PRSCR/L2525M16	25	25	150	32	RCM.1606MO	1409
PRSCR/L3225P16	32	25	170	32		1529
PRSCR/L3232P20	32	32	170	40	RCM.2006MO	1819
PRSCR/L4040S20	40	40	250	50		2449
PRSCR/L4040S25	40	40	250	50	RCM.2507MO	2449
PRSCR/L5050T32	50	50	300	63	RCM.3209MO	3775

Označení destičky	CZK/ks bez DPH
RCMT1003MO	89
RCMT1204MO	115
RCMT1606MO	200
RCMT2006MO	270
RCMT2507MO	425
RCMX3209MO	670



při objednání specifikujte na jaké použití chcete destičky= ocel, nerez, litina, aj., čím lépe materiál popíšete tím lepší variantu vám zvolíme

PRSNR/L na destičky RNMG

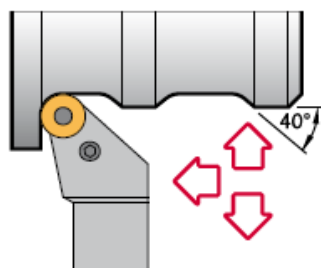
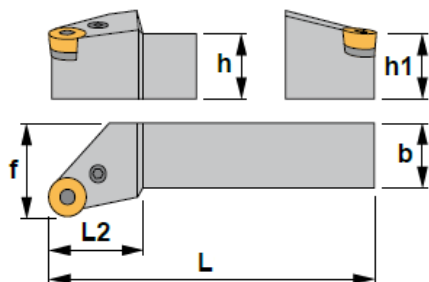

Označení	Rozměr (mm)				Označení destičky	CZK/ks bez DPH
	h	b	L	f		
PRSNR/L2020K09	20	20	125	25	RNMG090300	1325
PRSNR/L2525M12	25	25	150	32	RNMG120400	1409
PRSNR/L3225P15	32	25	170	32	RNMG150600	1529
PRSNR/L3232P19	32	32	170	40	RNMG190600	1819
PRSNR/L4040S25	40	40	250	50	RNMG250900	2449

Označení destičky	CZK/ks bez DPH
RNMG090300	99
RNMG120400	125
RNMG150600	179
RNMG190600	219
RNMG250900	500



PSBNR/L 75° na destičky SNMG/SNMA/SNMM/SNMX

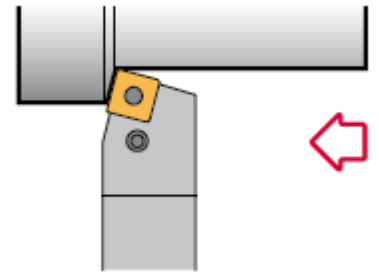
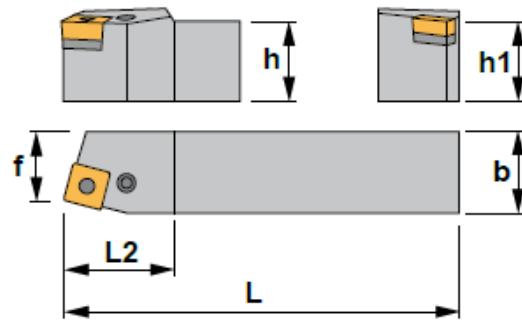

Označení	Rozměr (mm)				Označení destičky	CZK/ks bez DPH
	h	b	L	f		
PSBNR/L1212F09	12	12	80	11	SNM.0903..	1205
PSBNR/L1616H09	16	16	100	13		1020
PSBNR/L2020K09	20	20	125	17		1275
PSBNR/L2020K12	20	20	125	17	SNM.1204..	950
PSBNR/L2525M12K	25	25	150	22		999
PSBNR/L2525M12	25	25	125	22		1275
PSBNR/L3225P12	32	25	170	22	SNM.1506..	1529
PSBNR/L3232P12	32	32	170	27		1675
PSBNR/L2525M15	25	25	150	22		1145
PSBNR/L3232P15	32	32	170	27	SNM.1906..	1575
PSBNR/L3232P19	32	32	170	27		1409
PSBNR/L4040S19	40	40	250	35		1999
PSBNR/L5050T19	50	50	300	43	SNM.2507..	3775
PSBNR/L4040S2507	40	40	250	35		2020
PSBNR/L5050T25	50	50	300	43		3400
PSBNR/L4040S2509	40	40	250	35	SNM.2509..	2969

PSDNN 45° na destičky SNMG/SNMA/SNMM/SNMX

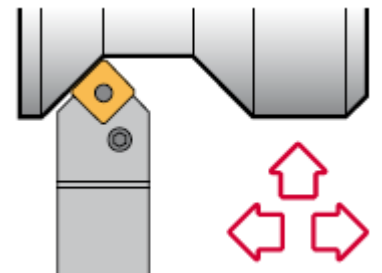
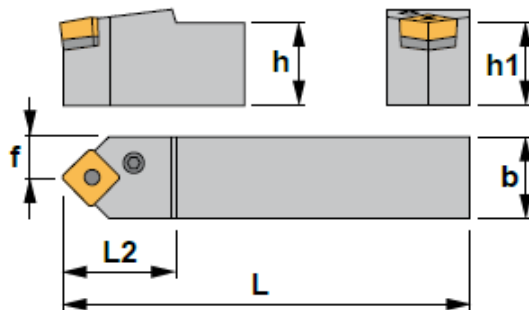

Označení	Rozměr (mm)				Označení destičky	CZK/ks bez DPH
	h	b	L	f		
PSDNN1010E09	10	10	70	5	SNM.0903..	1205
PSDNN1212F09	12	12	80	6		1055
PSDNN1616H09	16	16	100	8		1020
PSDNN2020K12	20	20	125	10,0	SNM.1204..	950
PSDNN2525M12	25	25	150	12,5		999
PSDNN3225P12	32	25	170	12,5		1529
PSDNN3232P12	32	32	170	16	SNM.1506..	1409
PSDNN2525M15	25	25	150	12,5		1119
PSDNN3232P15	32	32	170	16		1469
PSDNN3225P19	32	25	170	12,5	SNM.1906..	1529
PSDNN3232P19	32	32	170	16,0		1409
PSDNN4040S19	40	40	250	20		2419
PSDNN4040S25	40	40	250	20	SNM.2507..	2020
PSDNN5050T25	50	50	300	25		3775

PSSNR/L 45° na destičky SNMG/SNMA/SNMM/SNMX

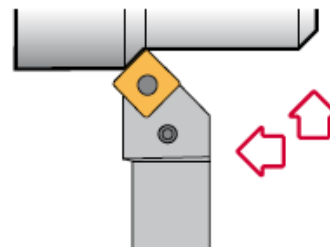
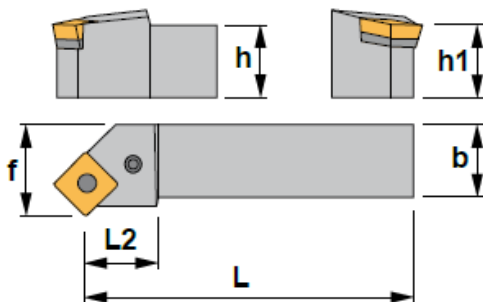

Označení	Rozměr (mm)				Označení destičky	CZK/ks bez DPH
	h	b	L	f		
PSSNR/L1616H09	16	16	100	20	SNM.0903..	999
PSSNR/L2020K09	20	20	125	25		1165
PSSNR/L2020K12	20	20	125	25	SNM.1204..	950
PSSNR/L2525M12	25	25	150	32		999
PSSNR/L3225P12	32	25	170	32		1529
PSSNR/L3232P12	32	32	170	40		1409
PSSNR/L2525M15	25	25	150	32	SNM.1506..	1119
PSSNR/L3225P15	32	25	170	32		1529
PSSNR/L3232P15	32	32	170	40	SNM.1906..	1469
PSSNR/L3232P19	32	32	170	40		1409
PSSNR/L4040S19	40	40	250	50	SNM.2507..	2020
PSSNR/L5050T19	50	50	300	60		3775
PSSNR/L4040S2507	40	40	250	50	SNM.2509..	2449
PSSNR/L4040S2509	40	40	250	50		2969
PSSNR/L5050T25	50	50	300	60	3775	

PSKNR/L 75° na destičky SNMG/SNMA/SNMM/SNMX

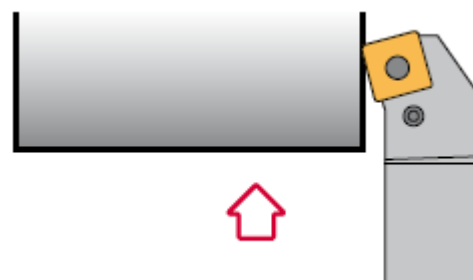
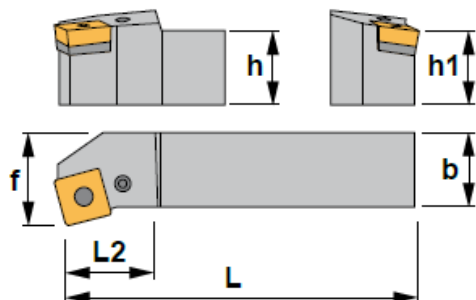

Označení	Rozměr (mm)				Označení destičky	CZK/ks bez DPH
	h	b	L	f		
PSKNR/L1616H09	16	16	100	20	SNM.0903..	999
PSKNR/L2020K09	20	20	125	25		1119
PSKNR/L2020K12	20	20	125	25	SNM.1204..	999
PSKNR/L2525M12	25	25	150	32		999
PSKNR/L3225P12	32	25	170	32		1529
PSKNR/L3232P12	32	32	170	40		1469
PSKNR/L2525M15	25	25	150	32	SNM.1506..	1119
PSKNR/L3232P15	32	32	170	40		1409
PSKNR/L3232P19	32	32	170	40	SNM.1906..	1469
PSKNR/L4040S19	40	40	250	50		2020
PSKNR/L4040S25	40	40	250	50	SNM.2509..	2449
PSKNR/L5050T25	50	50	300	60		3775

Označení destičky	CZK/ks bez DPH
SNMG090308	99
SNMG120408	119
SNMG150608	199
SNMG190608	250
SNMG250724	560
SNMG250924	560



při objednání specifikujte na jaké použití chcete destičky= ocel, nerez, litina, aj., čím lépe materiál popíšete tím lepší variantu vám zvolíme, také pokud by jste raději jiný RÁDIUS či typ SNMA/SNMM/SNMX napište si to do požadavků

PTDNR/L 45° na destičky TNMG/TNMA/TNMM/TNMX

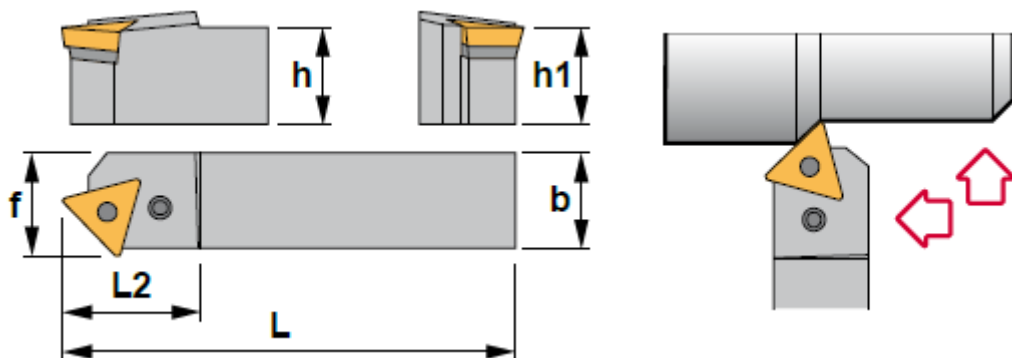

Označení	Rozměr (mm)				Označení destičky	CZK/ks bez DPH
	h	b	L	f		
PTDNR/L2525M22	25	25	150	27	TNM.2204..	1409
PTDNR/L3225P22	32	25	170	27		1529

PTFNR/L 90° 91° na destičky TNMG/TNMA/TNMM/TNMX

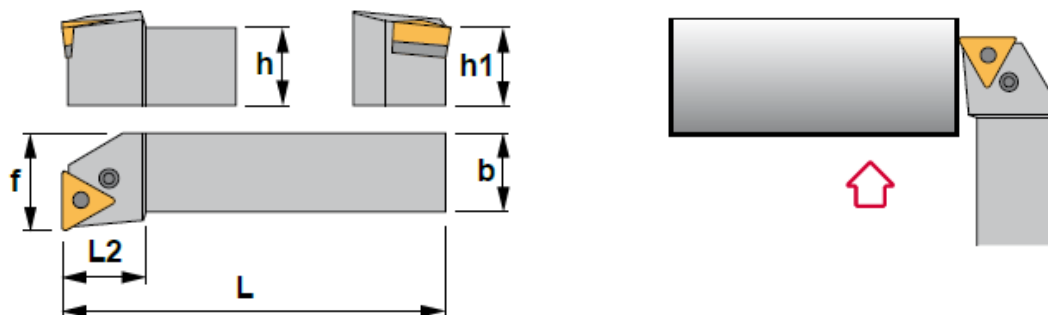

Označení	Rozměr (mm)				Označení destičky	CZK/ks bez DPH
	h	b	L	f		
PTFNR/L1616H16	16	16	100	20	TNM.1604..	999
PTFNR/L2020K16	20	20	125	25		999
PTFNR/L2525M16	25	25	150	32		999
PTFNR/L3225P16 90°	32	25	170	32	TNM.2204..	1529
PTFNR/L2525M22	25	25	150	32		1119
PTFNR/L3225P22 90°	32	25	170	32	TNM.2706..	1529
PTFNR/L3232P22	32	32	170	40		1409
PTFNR/L3232P27	32	32	170	40	TNM.2706..	1469
PTFNR/L4040S27	40	40	250	50		2419

PTTNR/L 60° na destičky TNMG/TNMA/TNMM/TNMX

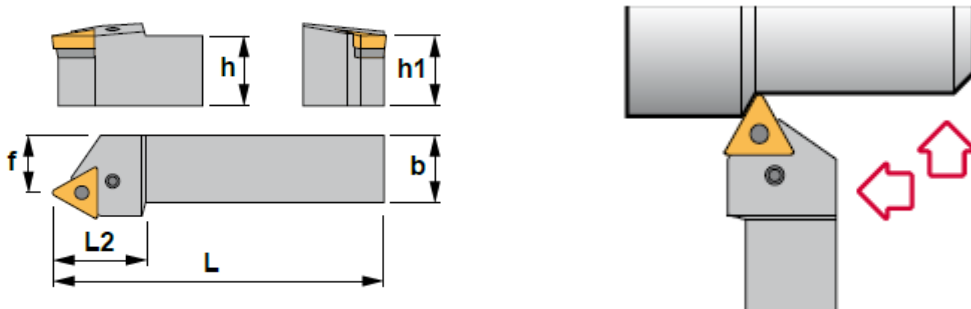

Označení	Rozměr (mm)				Označení destičky	CZK/ks bez DPH
	h	b	L	f		
PTTNR/L1616H16	16	16	100	13	TNM.1604..	999
PTTNR/L2020K16	20	20	125	17		999
PTTNR/L2525M16	25	25	150	22		999
PTTNR/L2525M22	25	25	150	22	TNM.2204..	1119
PTTNR/L3225P22	32	25	170	22		1529

PTGNR/L 90° na destičky TNMG/TNMA/TNMM/TNMX

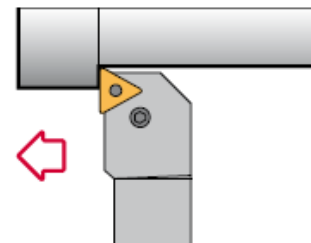
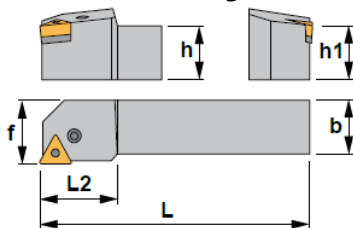

Označení	Rozměr (mm)				Označení destičky	CZK/ks bez DPH
	h	b	L	f		
PTGNR/L1010E11	10	10	70	14	TNM.1103..	919
PTGNR/L1212F11	12	12	80	16		919
PTGNR/L1616H11	16	16	100	20		999
PTGNR/L2020K11	20	20	125	25		1119
PTGNR/L2525M11	25	25	150	32		1119
PTGNR/L1616H16	16	16	100	20	TNM.1604..	999
PTGNR/L2020K16	20	20	125	25		950
PTGNR/L2525M16	25	25	150	32		999
PTGNR/L3225P16	32	25	170	32		1529
PTGNR/L3232P16	32	32	170	40		1469
PTGNR/L2525M22	25	25	150	32	TNM.2204..	999
PTGNR/L3225P22	32	25	170	32		1529
PTGNR/L3232P22	32	32	170	40		1469
PTGNR/L4040S22	40	40	250	50		2449
PTGNR/L3232P27	32	32	170	40		1469
PTGNR/L4040S27	40	40	250	50	TNM.2706..	2419
PTGNR/L5050T33	50	50	300	60		TNM.3307..

PTGNR/L-K 91° na destičky TNMG/TNMA/TNMM/TNMX

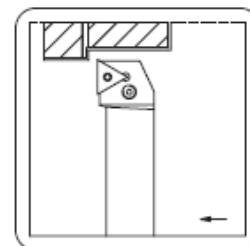
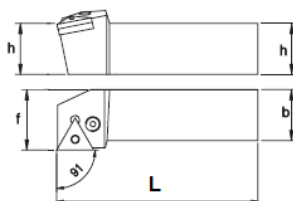

Označení	Rozměr (mm)				Označení destičky	CZK/ks bez DPH
	h	b	L	f		
PTGNR/L2020K16K	20	20	125	25	TNM.1604..	999
PTGNR/L2525M16K	25	25	150	32		999
PTGNR/L3225P16K	32	25	170	32		1120
PTGNR/L3232P22K	32	32	170	40	TNM.2204..	1409

PTJNR/L 93° na destičky TNMG/TNMA/TNMM/TNMX

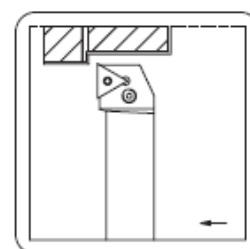
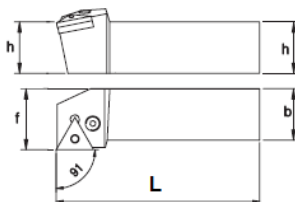

Označení	Rozměr (mm)				Označení destičky	CZK/ks bez DPH
	h	b	L	f		
PTJNR/L2020K16	20	20	125	25	TNM.1604..	999
PTJNR/L2525M16	25	25	150	32		999
PTJNR/L3225P16	32	25	170	32		1120
PTJNR/L3232P22	32	32	170	40	TNM.2204..	1409

Označení destičky	CZK/ks bez DPH
TNMG110308	89
TNMG160408	119
TNMG220408	159
TNMG270608	250
TNMG330724	379



při objednání specifikujte na jaké použití chcete destičky= ocel, nerez, litina, aj., čím lépe materiál popíšete tím lepší variantu vám zvolíme, také pokud by jste raději jiný RÁDIUS či typ TNMA/TNMM/TNMX napište si to do požadavků

PWLNR/L 95° na destičky WNMG/WNMA

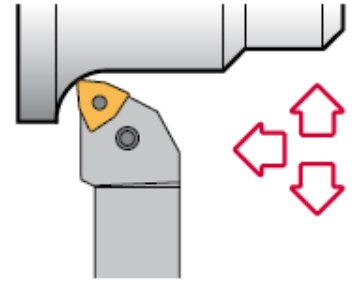
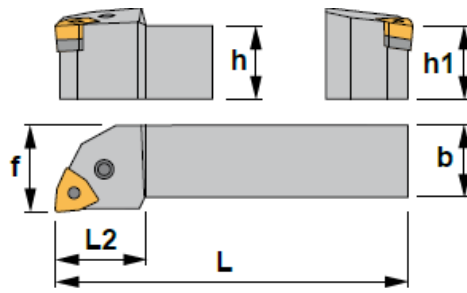

Označení	Rozměr (mm)				Označení destičky	CZK/ks bez DPH
	h	b	L	f		
PWLNR/L1616H06	16	16	100	20	WNM.0604..	999
PWLNR/L2020K06	20	20	125	25		1035
PWLNR/L2525M06	25	25	150	32		1060
PWLNR/L2020K08	20	20	125	25	WNM.0804..	950
PWLNR/L2525M08	25	25	150	32		999
PWLNR/L3225P08	32	25	170	32		1529
PWLNR/L3232P08	32	32	170	40		1225

Označení destičky	CZK/ks bez DPH
WNMG060408	109
WNMG080408	140

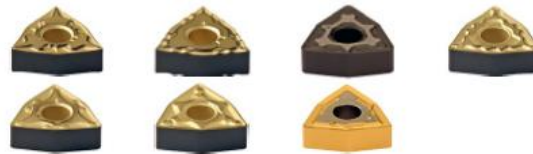

při objednání specifikujte na jaké použití chcete destičky= ocel, nerez, litina, aj., čím lépe materiál popíšete tím lepší variantu vám zvolíme
také pokud by jste raději jiný RÁDIUS či typ WNMA napište si to do požadavků

ALICON s.r.o. Váš partner v třískovém obrábění

Vápencová 547/4, 147 00 Praha 4, IČ: 28179706, DIČ: CZ28179706
Tel: +420774317627, Fax: +420227203615, email: info@alicon.cz, www.alicontool.cz