

VRTÁKY NA HLINÍKOVÉ SLITINY A LITINU BEZ VNITŘNÍHO CHLAZENÍ

3xD a 5xD

Tvrdokovové vrtáky pro vrtání litiny a hliníkové slitiny. Vrták průměr tolerance h8, stopka tolerance h7

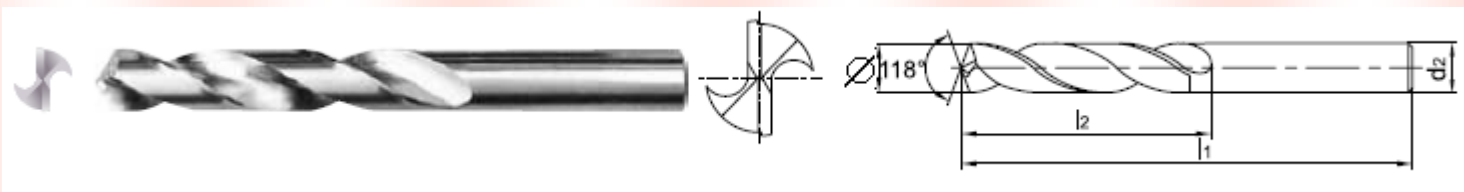

Označení 3xD	Rozměry v mm				CZK/ks bez DPH
	Průměr	L2	L1	d2	
AC.AL.3D.020	2	12	38	2	155
AC.AL.3D.022	2,2	14	43	2	159
AC.AL.3D.025	2,5	14	43	3	159
AC.AL.3D.028	2,8	16	46	3	179
AC.AL.3D.030	3	16	46	3	160
AC.AL.3D.031	3,1	18	49	3	175
AC.AL.3D.032	3,2	18	49	3	175
AC.AL.3D.033	3,3	18	49	3	175
AC.AL.3D.034	3,4	20	52	3	175
AC.AL.3D.035	3,5	20	52	4	175
AC.AL.3D.036	3,6	20	52	4	175
AC.AL.3D.037	3,7	20	52	4	180
AC.AL.3D.038	3,8	22	55	4	180
AC.AL.3D.039	3,9	22	55	4	180
AC.AL.3D.040	4	22	55	4	180
AC.AL.3D.041	4,1	22	55	4	195
AC.AL.3D.042	4,2	22	55	4	195
AC.AL.3D.043	4,3	24	58	4	199
AC.AL.3D.044	4,4	24	58	4	199
AC.AL.3D.045	4,5	24	58	5	199
AC.AL.3D.046	4,6	24	58	5	199
AC.AL.3D.048	4,8	26	62	5	200
AC.AL.3D.049	4,9	26	62	5	200
AC.AL.3D.050	5	26	62	5	200
AC.AL.3D.051	5,1	26	62	5	229
AC.AL.3D.052	5,2	26	62	5	229
AC.AL.3D.053	5,3	26	62	5	229
AC.AL.3D.054	5,4	28	66	5	309
AC.AL.3D.055	5,5	28	66	6	309
AC.AL.3D.056	5,6	28	66	6	309
AC.AL.3D.057	5,7	28	66	6	309
AC.AL.3D.058	5,8	28	66	6	309
AC.AL.3D.060	6	28	66	6	309
AC.AL.3D.061	6,1	31	70	6	315
AC.AL.3D.062	6,2	31	70	6	315
AC.AL.3D.063	6,3	31	70	6	315
AC.AL.3D.064	6,4	31	70	6	315
AC.AL.3D.065	6,5	31	70	7	449

Označení 3xD	Rozměry v mm				CZK/ks bez DPH
	Průměr	L2	L1	d2	
AC.AL.3D.066	6,6	31	70	6,6	449
AC.AL.3D.067	6,7	31	70	6,7	449
AC.AL.3D.068	6,8	34	74	6,8	459
AC.AL.3D.070	7	34	74	7	459
AC.AL.3D.071	7,1	34	74	7,1	509
AC.AL.3D.072	7,2	34	74	7,2	509
AC.AL.3D.074	7,4	34	74	7,4	509
AC.AL.3D.075	7,5	34	74	7,5	509
AC.AL.3D.078	7,8	37	79	7,8	525
AC.AL.3D.079	7,9	37	79	7,9	525
AC.AL.3D.080	8	37	79	8	525
AC.AL.3D.081	8,1	37	79	8,1	580
AC.AL.3D.082	8,2	37	79	8,2	580
AC.AL.3D.084	8,4	37	79	8,4	580
AC.AL.3D.085	8,5	37	79	8,5	580
AC.AL.3D.086	8,6	40	84	8,6	599
AC.AL.3D.087	8,7	40	84	8,7	599
AC.AL.3D.090	9	40	84	9	599
AC.AL.3D.091	9,1	40	84	9,1	665
AC.AL.3D.092	9,2	40	84	9,2	665
AC.AL.3D.093	9,3	40	84	9,3	665
AC.AL.3D.095	9,5	40	84	9,5	665
AC.AL.3D.098	9,8	43	89	9,8	685
AC.AL.3D.099	9,9	43	89	9,9	685
AC.AL.3D.100	10	43	89	10	685
AC.AL.3D.101	10,1	43	89	10	799
AC.AL.3D.102	10,2	43	89	10	799
AC.AL.3D.104	10,4	43	89	10	799
AC.AL.3D.105	10,5	43	89	11	799
AC.AL.3D.108	10,8	47	95	11	835
AC.AL.3D.110	11	47	95	11	835
AC.AL.3D.115	11,5	47	95	12	995
AC.AL.3D.120	12	51	102	12	995
AC.AL.3D.121	12,1	51	102	12	1205
AC.AL.3D.125	12,5	51	102	13	1205
AC.AL.3D.130	13	51	102	13	1205
AC.AL.3D.140	14	54	107	14	1382
AC.AL.3D.150	15	56	111	15	1699
AC.AL.3D.160	16	58	115	16	1919

Označení 5xD	Rozměry v mm				CZK/ks bez DPH
	Průměr	L2	L1	d2	
AC.AL.5D.020	2	24	49	2	160
AC.AL.5D.025	2,5	30	57	2,5	235
AC.AL.5D.028	2,8	33	61	2,8	235
AC.AL.5D.030	3	33	61	3	235
AC.AL.5D.033	3,3	39	70	3,3	265
AC.AL.5D.035	3,5	39	70	3,5	265
AC.AL.5D.038	3,8	43	75	3,8	270
AC.AL.5D.040	4	43	75	4	270
AC.AL.5D.042	4,2	43	75	4,2	289
AC.AL.5D.045	4,5	47	80	4,5	340
AC.AL.5D.048	4,8	52	86	4,8	350
AC.AL.5D.050	5	52	86	5	350
AC.AL.5D.055	5,5	57	93	5,5	445
AC.AL.5D.058	5,8	57	93	5,8	445
AC.AL.5D.060	6	57	93	6	445
AC.AL.5D.064	6,4	63	101	6,4	619
AC.AL.5D.065	6,5	63	101	6,5	619
AC.AL.5D.068	6,8	69	109	6,8	639
AC.AL.5D.069	6,9	69	109	6,9	639

Označení 5xD	Rozměry v mm				CZK/ks bez DPH
	Průměr	L2	L1	d2	
AC.AL.5D.070	7	69	109	7	639
AC.AL.5D.075	7,5	69	109	7,5	729
AC.AL.5D.078	7,8	75	117	7,8	759
AC.AL.5D.080	8	75	117	8	759
AC.AL.5D.082	8,2	75	117	8,2	859
AC.AL.5D.085	8,5	75	117	8,5	859
AC.AL.5D.088	8,8	81	125	8,8	859
AC.AL.5D.090	9	81	125	9	895
AC.AL.5D.095	9,5	81	125	9,5	1005
AC.AL.5D.098	9,8	87	133	9,8	1089
AC.AL.5D.100	10	87	133	10	1089
AC.AL.5D.105	10,5	87	133	10,5	1289
AC.AL.5D.110	11	94	142	11	1289
AC.AL.5D.118	11,8	94	142	11,8	1635
AC.AL.5D.125	12,5	101	151	12,5	2045
AC.AL.5D.130	13	101	151	13	2045
AC.AL.5D.135	13,5	108	160	13,5	2389
AC.AL.5D.140	14	108	160	14	2649
AC.AL.5D.145	14,5	114	169	14,5	3060
AC.AL.5D.160	16	120	178	16	3720

TVRDOKOVOVÉ VRTÁKY 3XD BEZ VNITŘNÍHO CHLAZENÍ A NEPOVLAKOVANÉ

Tvrdokovové vrtáky pro vrtání běžných ocelí, hliníkových slitin, mosazi, bronzu a plastu. Výborná ostrost a pevnost, podporuje dobrý odvod špon. Vrták průměr tolerance **h8**, stopka tolerance **h6**

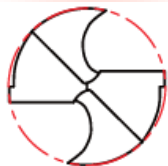
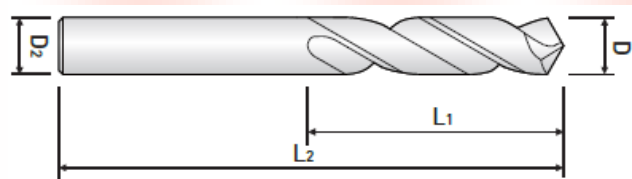

Označení	Rozměry (v mm)				CZK/ks bez DPH	
	Průměr	L1	L2	D2		
SSD010	1.0	10	38	1.0	120	
SSD011	1.1			1.1		
SSD012	1.2			1.2		
SSD013	1.3			1.3		
SSD014	1.4			1.4		
SSD015	1.5	13	38	1.5	120	
SSD016	1.6			1.6		
SSD017	1.7			1.7		
SSD018	1.8			1.8		
SSD019	1.9			1.9		
SSD020	2.0	16	45	2.0	120	
SSD021	2.1			2.1		
SSD022	2.2			2.2		
SSD023	2.3			2.3		
SSD024	2.4			2.4		
SSD025	2.5	20	50	2.5	120	
SSD026	2.6			2.6		
SSD027	2.7	22	50	2.7	120	
SSD028	2.8			2.8		
SSD029	2.9			2.9		
SSD030	3.0			3.0		129
SSD031	3.1			25		50
SSD032	3.2	3.2				
SSD033	3.3	3.3				
SSD034	3.4	3.4				
SSD035	3.5	3.5				
SSD036	3.6	28	55	3.6	145	
SSD037	3.7			3.7		
SSD038	3.8			3.8		
SSD039	3.9			3.9		
SSD040	4.0			4.0		
SSD041	4.1	30	60	4.1	175	
SSD042	4.2			4.2		
SSD043	4.3			4.3		
SSD044	4.4			4.4		
SSD045	4.5			4.5		195

Označení	Rozměry (v mm)				CZK/ks bez DPH	
	Průměr	L1	L2	D2		
SSD046	4.6	33	65	4.6	219	
SSD047	4.7			4.7		
SSD048	4.8	35	65	4.8	219	
SSD049	4.9			4.9		
SSD050	5.0			5.0		235
SSD051	5.1			5.1		255
SSD052	5.2			5.2		
SSD053	5.3	5.3				
SSD054	5.4	5.4	275			
SSD055	5.5	5.5				
SSD056	5.6	38	75	5.6	295	
SSD057	5.7			5.7		
SSD058	5.8			5.8		
SSD059	5.9			5.9		
SSD060	6.0			6.0		
SSD061	6.1	38	75	6.1	295	
SSD062	6.2			6.2		
SSD063	6.3	45	80	6.3	375	
SSD064	6.4			6.4		
SSD065	6.5			6.5		
SSD066	6.6			6.6		
SSD067	6.7			6.7		
SSD068	6.8	45	80	6.8	375	
SSD069	6.9			6.9		
SSD070	7.0	45	80	7.0	419	
SSD071	7.1			7.1		
SSD072	7.2			7.2		
SSD073	7.3			7.3		
SSD074	7.4			7.4		
SSD075	7.5	50	85	7.5	455	
SSD076	7.6			7.6		
SSD077	7.7			7.7		
SSD078	7.8			7.8		
SSD079	7.9			7.9		
SSD080	8.0	50	85	8.0	499	
SSD081	8.1			8.1		
SSD082	8.2			8.2		
SSD083	8.3			8.3		
SSD084	8.4			8.4		
SSD085	8.5	8.5				

Označení	Rozměry (v mm)				CZK/ks bez DPH			
	Průměr	L1	L2	D2				
SSD086	8.6	50	95	8.6	539			
SSD087	8.7			8.7				
SSD088	8.8			8.8				
SSD089	8.9			8.9				
SSD090	9.0			9.0				
SSD091	9.1	55	100	9.1	580			
SSD092	9.2			9.2				
SSD093	9.3			9.3				
SSD094	9.4			9.4				
SSD095	9.5			9.5				
SSD096	9.6	55	100	9.6	620			
SSD097	9.7			9.7				
SSD098	9.8	55	115	9.8	670			
SSD099	9.9			9.9				
SSD100	10.0			10.0				
SSD101	10.1	55	115	10.1	670			
SSD102	10.2			10.2				
SSD103	10.3	55	115	10.3	855			
SSD104	10.4			10.4				
SSD105	10.5			10.5				
SSD106	10.6			60		115	10.6	855
SSD107	10.7						10.7	
SSD108	10.8	60	115	10.8	949			
SSD109	10.9			10.9				
SSD110	11.0			11.0				
SSD111	11.1	65	120	11.1	960			
SSD112	11.2			11.2				
SSD113	11.3			11.3				
SSD115	11.5			11.5				
SSD118	11.8			11.8				
SSD119	11.9	65	120	11.9	1275			
SSD120	12.0			12.0				
SSD124	12.4	70	125	12.4	1419			
SSD125	12.5			12.5				
SSD130	13.0	75	130	13.0	1570			

■ Tolerance

µm = 1/1000mm

Tolerance \ Dia.	from 1 to 3	over 3 to 6	over 6 to 10	over 10 to 18
Cutting Edge(h8)	0 -14	0 -18	0 -22	0 -27
Shank(h6)	0 -10	0 -12	0 -15	0 -18

TVRDOKOVOVÉ VRTÁKY 5XD BEZ VNITŘNÍHO CHLAZENÍ A NEPOVLAKOVANÉ

Tvrdokovové vrtáky pro vrtání běžných ocelí, hliníkových slitin, mosazi, bronzu a plastu. Výborná ostrost a pevnost, podporuje dobrý odvod špon. Vrták průměr tolerance **h8**, stopka tolerance **h6**

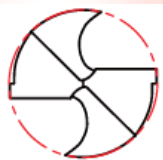
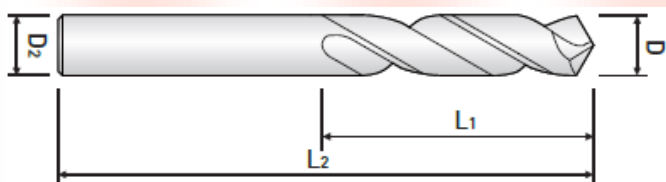

Označení	Rozměry (v mm)				CZK/ks bez DPH
	Průměr	L1	L2	D2	
SSDL030	3.0	42	73	3.0	245
SSDL031	3.1				
SSDL032	3.2				
SSDL033	3.3				
SSDL034	3.4				
SSDL035	3.5				
SSDL036	3.6	45	80	3.6	245
SSDL037	3.7				
SSDL038	3.8				
SSDL039	3.9	50	80	3.9	245
SSDL040	4.0				
SSDL041	4.1	54	85	4.1	270
SSDL042	4.2				
SSDL043	4.3				
SSDL044	4.4				
SSDL045	4.5				
SSDL046	4.6				
SSDL047	4.7	59	90	4.7	305
SSDL048	4.8				
SSDL049	4.9				
SSDL050	5.0				
SSDL051	5.1				
SSDL052	5.2				
SSDL053	5.3	63	95	5.3	350
SSDL054	5.4				
SSDL055	5.5				
SSDL056	5.6				
SSDL057	5.7	66	100	5.7	365
SSDL058	5.8				
SSDL059	5.9				
SSDL060	6.0				
SSDL061	6.1	70	105	6.1	449
SSDL062	6.2				
SSDL063	6.3				
SSDL064	6.4				
SSDL065	6.5				

Označení	Rozměry (v mm)				CZK/ks bez DPH
	Průměr	L1	L2	D2	
SSDL066	6.6	73	105	6.6	499
SSDL067	6.7				
SSDL068	6.8				
SSDL069	6.9				
SSDL070	7.0				
SSDL071	7.1				
SSDL072	7.2	76	110	7.2	549
SSDL073	7.3				
SSDL074	7.4				
SSDL075	7.5				
SSDL076	7.6	80	115	7.6	580
SSDL077	7.7				
SSDL078	7.8				
SSDL079	7.9				
SSDL080	8.0				
SSDL081	8.1				
SSDL082	8.2	85	125	8.2	655
SSDL083	8.3				
SSDL084	8.4				
SSDL085	8.5				
SSDL086	8.6				
SSDL087	8.7				
SSDL088	8.8	88	130	8.8	699
SSDL089	8.9				
SSDL090	9.0				
SSDL091	9.1				
SSDL092	9.2	90	130	9.2	715
SSDL093	9.3				
SSDL094	9.4				
SSDL095	9.5				
SSDL096	9.6	90	130	9.6	765
SSDL097	9.7				
SSDL098	9.8				
SSDL099	9.9				
SSDL100	10.0				

■ Tolerance

μm = 1/1000mm

Tolerance	Dia.	from 1 to 3	over 3 to 6	over 6 to 10	over 10 to 18
Cutting Edge(h8)		0 -14	0 -18	0 -22	0 -27
Shank(h6)		0 -10	0 -12	0 -15	0 -18

TVRDOKOVOVÉ VRTÁKY 3XD BEZ VNITŘNÍHO CHLAZENÍ POVLAKOVANÉ

Nové inovované tvrdokovové vrtáky s povlakem TiN pro vrtání běžných ocelí, hliníkových slitin, mosazi, bronzu a plastu. Výborná ostrost a pevnost, podporuje dobrý odvod špon. Vrták průměr tolerance **h8**, stopka tolerance **h6**

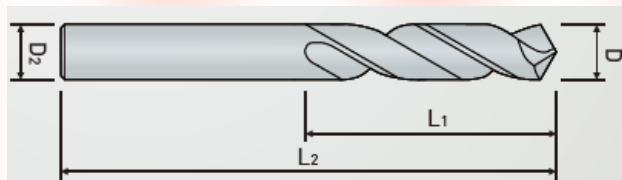

Označení	Rozměry (v mm)				CZK/ks bez DPH			
	Průměr	L1	L2	D2				
SSTD005	0.5	6	22	0.5	255			
SSTD0055	0.55	7	24	0.55	245			
SSTD006	0.6			0.6	245			
SSTD0065	0.65	8	26	0.65	220			
SSTD007	0.7	9	28	0.7	210			
SSTD0075	0.75			0.75	199			
SSTD008	0.8	10	30	0.8	189			
SSTD0085	0.85			0.85	179			
SSTD009	0.9	11	32	0.9	169			
SSTD0095	0.95			0.95	155			
SSTD010	1	10	38	1	115			
SSTD011	1.1			1.1				
SSTD012	1.2			1.2				
SSTD013	1.3			1.3				
SSTD014	1.4			1.4				
SSTD015	1.5	13	38	1.5	115			
SSTD016	1.6			1.6				
SSTD017	1.7			1.7				
SSTD018	1.8			1.8				
SSTD019	1.9			1.9				
SSTD020	2	16	45	2	115			
SSTD021	2.1			2.1				
SSTD022	2.2			2.2				
SSTD023	2.3			2.3				
SSTD024	2.4	18	50	2.4	115			
SSTD025	2.5	20	50	2.5	115			
SSTD026	2.6			2.6				
SSTD027	2.7	22	50	2.7	115			
SSTD028	2.8			2.8				
SSTD029	2.9			2.9				
SSTD030	3			3		120		
SSTD031	3.1			25		50	3.1	120
SSTD032	3.2	3.2						
SSTD033	3.3	3.3						
SSTD034	3.4	3.4						
SSTD035	3.5	3.5						
SSTD036	3.6	28	55		3.6		135	
SSTD037	3.7				3.7			
SSTD038	3.8				3.8			
SSTD039	3.9			3.9				
SSTD040	4			4				

Označení	Rozměry (v mm)				CZK/ks bez DPH		
	Průměr	L1	L2	D2			
SSTD041	4.1	30	60	4.1	165		
SSTD042	4.2			4.2			
SSTD043	4.3			4.3			
SSTD044	4.4			4.4			
SSTD045	4.5			4.5		185	
SSTD046	4.6	33	65	4.6	205		
SSTD047	4.7			4.7			
SSTD048	4.8	35	65	4.8	205		
SSTD049	4.9			4.9		219	
SSTD050	5			5		219	
SSTD051	5.1			5.1		235	
SSTD052	5.2			5.2			
SSTD053	5.3	5.3	38	75	279		
SSTD054	5.4	5.4					
SSTD055	5.5	5.5				255	
SSTD056	5.6	5.6					
SSTD057	5.7	5.7					
SSTD058	5.8	5.8	315				
SSTD059	5.9	5.9					
SSTD060	6	38	75	6	320		
SSTD061	6.1			6.1			
SSTD062	6.2			6.2		315	
SSTD063	6.3			6.3			
SSTD064	6.4	6.4	45	80	390		
SSTD065	6.5	6.5				320	
SSTD066	6.6	6.6				350	
SSTD067	6.7	6.7					350
SSTD068	6.8	6.8					829
SSTD069	6.9	6.9	829				
SSTD070	7	7	60	115	829		
SSTD071	7.1	7.1				390	
SSTD072	7.2	7.2					390
SSTD073	7.3	7.3					425
SSTD074	7.4	7.4					
SSTD075	7.5	7.5	50	85	425		
SSTD076	7.6	7.6				425	
SSTD077	7.7	7.7				1115	
SSTD078	7.8	7.8					1115
SSTD079	7.9	7.9					1245
SSTD080	8	8	1245				

Označení	Rozměry (v mm)				CZK/ks bez DPH			
	Průměr	L1	L2	D2				
SSTD081	8.1	50	85	8.1	465			
SSTD082	8.2			8.2				
SSTD083	8.3			8.3				
SSTD084	8.4			8.4				
SSTD085	8.5			8.5				
SSTD086	8.6	50	95	8.6	505			
SSTD087	8.7			8.7				
SSTD088	8.8			8.8				
SSTD089	8.9			8.9				
SSTD090	9			9				
SSTD091	9.1	50	95	9.1	545			
SSTD092	9.2			9.2				
SSTD093	9.3			9.3				
SSTD094	9.4			9.4				
SSTD095	9.5			9.5				
SSTD096	9.6	55	100	9.6	580			
SSTD097	9.7			9.7				
SSTD098	9.8			9.8				
SSTD099	9.9			9.9				
SSTD100	10			10		55	115	799
SSTD101	10.1	10.1						
SSTD102	10.2	10.2						
SSTD103	10.3	10.3						
SSTD104	10.4	10.4						
SSTD105	10.5	10.5	60	115	799			
SSTD106	10.6	10.6						
SSTD107	10.7	10.7						
SSTD108	10.8	10.8						
SSTD109	10.9	10.9						
SSTD110	11	11	60	115	829			
SSTD111	11.1	11.1						
SSTD112	11.2	11.2						
SSTD113	11.3	11.3						
SSTD115	11.5	11.5				65	120	840
SSTD118	11.8	11.8						
SSTD119	11.9	11.9						
SSTD120	12	12	70	125	1115			
SSTD124	12.4	12.4						
SSTD125	12.5	12.5				1245		
SSTD130	13	75				130	13	1375

Tolerance		$\mu\text{m} = 1/1000\text{mm}$			
Tolerance	Dia.	from 1 to 3	over 3 to 6	over 6 to 10	over 10 to 18
Cutting Edge(h8)		0 -14	0 -18	0 -22	0 -27
Shank(h6)		0 -10	0 -12	0 -15	0 -18

3 BŘITÉ VRTÁKY NA HLINÍKOVÉ SLITINY A LITINU BEZ VNITŘNÍHO CHLAZENÍ 3xD - S POVLAKEM NEBO BEZ POVLAKU!

Tvrdokovové vrtáky pro vrtání litiny a hliníkové slitiny. Vrták průměr tolerance h7, stopka tolerance h7

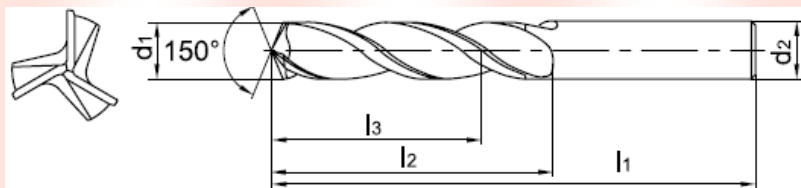

Označení	Rozměry (mm)					CZK/ks bez DPH s povlakem	CZK/ks bez DPH bez povlaku
	D1	L3	L2	L1	D2		
AC.3D.PA.030	3	12	16	46	3	309	255
AC.3D.PA.031	3,1	14	18	49	3,1	X	275
AC.3D.PA.032	3,2	14	18	49	3,2	325	275
AC.3D.PA.033	3,3	14	18	49	3,3	325	X
AC.3D.PA.034	3,4	15	20	52	3,4	329	275
AC.3D.PA.035	3,5	15	20	52	3,5	329	X
AC.3D.PA.038	3,8	17	22	55	3,8	330	X
AC.3D.PA.039	3,9	17	22	55	3,9	X	280
AC.3D.PA.040	4	17	22	55	4	330	280
AC.3D.PA.041	4,1	17	22	55	4,1	345	299
AC.3D.PA.042	4,2	17	22	55	4,2	345	299
AC.3D.PA.043	4,3	18	24	58	4,3	345	299
AC.3D.PA.044	4,4	18	24	58	4,4	X	299
AC.3D.PA.045	4,5	18	24	58	4,5	345	299
AC.3D.PA.046	4,6	18	24	58	4,6	X	299
AC.3D.PA.047	4,7	18	24	58	4,7	345	305
AC.3D.PA.048	4,8	20	26	62	4,8	X	305
AC.3D.PA.049	4,9	20	26	62	4,9	X	305
AC.3D.PA.050	5	20	26	62	5	350	305
AC.3D.PA.051	5,1	20	26	62	5,1	379	335
AC.3D.PA.052	5,2	20	26	62	5,2	379	335
AC.3D.PA.053	5,3	20	26	62	5,3	379	X
AC.3D.PA.054	5,4	21	28	66	5,4	X	339
AC.3D.PA.055	5,5	21	28	66	5,5	385	339
AC.3D.PA.056	5,6	21	28	66	5,6	X	385
AC.3D.PA.057	5,7	21	28	66	5,7	385	385
AC.3D.PA.058	5,8	21	28	66	5,8	385	X
AC.3D.PA.059	5,9	21	28	66	5,9	X	339
AC.3D.PA.060	6	21	28	66	6	480	415
AC.3D.PA.061	6,1	23	31	70	6,1	X	425
AC.3D.PA.062	6,2	23	31	70	6,2	X	425
AC.3D.PA.064	6,4	23	31	70	6,4	490	425
AC.3D.PA.065	6,5	23	31	70	6,5	490	425
AC.3D.PA.066	6,6	23	31	70	6,6	490	425
AC.3D.PA.067	6,7	23	31	70	6,7	490	425
AC.3D.PA.068	6,8	25	34	74	6,8	499	435
AC.3D.PA.069	6,9	25	34	74	6,9	X	435

Označení	Rozměry (mm)					CZK/ks bez DPH s povlakem	CZK/ks bez DPH bez povlaku
	D1	L3	L2	L1	D2		
AC.3D.PA.070	7	25	34	74	7	499	435
AC.3D.PA.071	7,1	25	34	74	7,1	X	495
AC.3D.PA.072	7,2	25	34	74	7,2	X	495
AC.3D.PA.073	7,3	25	34	74	7,3	X	495
AC.3D.PA.074	7,4	25	34	74	7,4	545	495
AC.3D.PA.075	7,5	25	34	74	7,5	545	495
AC.3D.PA.076	7,6	27	37	79	7,6	X	495
AC.3D.PA.078	7,8	27	37	79	7,8	X	495
AC.3D.PA.079	7,9	27	37	79	7,9	X	495
AC.3D.PA.080	8	27	37	79	8	570	495
AC.3D.PA.081	8,1	27	37	79	8,1	645	550
AC.3D.PA.082	8,2	27	37	79	8,2	X	550
AC.3D.PA.0825	8,25	27	37	79	8,5	645	X
AC.3D.PA.085	8,5	27	37	79	8,5	645	550
AC.3D.PA.086	8,6	29	40	84	8,6	X	570
AC.3D.PA.087	8,7	29	40	84	8,7	659	X
AC.3D.PA.088	8,8	29	40	84	8,8	659	X
AC.3D.PA.090	9	29	40	84	9	659	570
AC.3D.PA.095	9,5	29	40	84	9,5	715	X
AC.3D.PA.098	9,8	31	43	89	9,8	739	X
AC.3D.PA.099	9,9	31	43	89	9,9	X	650
AC.3D.PA.100	10	31	43	89	10	739	650
AC.3D.PA.102	10,2	31	43	89	10,2	849	X
AC.3D.PA.103	10,3	31	43	89	10,3	849	X
AC.3D.PA.105	10,5	31	43	89	10,5	849	X
AC.3D.PA.110	11	33	47	95	11	885	789
AC.3D.PA.115	11,5	33	47	95	11,5	979	939
AC.3D.PA.120	12	35	51	102	12	1025	939
AC.3D.PA.125	12,5	35	51	102	12,5	1345	1195
AC.3D.PA.130	13	35	51	102	13	X	1270
AC.3D.PA.135	13,5	37	54	107	13,5	1620	X
AC.3D.PA.140	14	37	54	107	14	1620	X
AC.3D.PA.145	14,5	38	56	111	14,5	1885	X
AC.3D.PA.150	15	38	56	111	15	1885	X
AC.3D.PA.160	16	38	58	115	16	2505	X
AC.3D.PA.170	17	39	60	119	17	X	2595
AC.3D.PA.180	18	40	62	123	18	3305	2895
AC.3D.PA.200	20	42	66	131	20	3760	X

!!! VOLBU S POVLAKEM ČI BEZ POVLAKU SPECIFIKUJTE PŘI OBJEDNÁNÍ !!!

PŘESNÉ VRTÁKY S ROVNOU ŠROUBOVICÍ NA HLINÍKOVÉ SLITINY A LITINU PRO MATERIÁL S KRÁTKOU TŘÍSKOU 5xD a 15xD - S CHLAZENÍM I BEZ CHLAZENÍ

Výborná středící schopnost, může dosáhnout přesnosti díry h7, výborný povrch.
Vrták průměr tolerance m7, stopka tolerance h6.

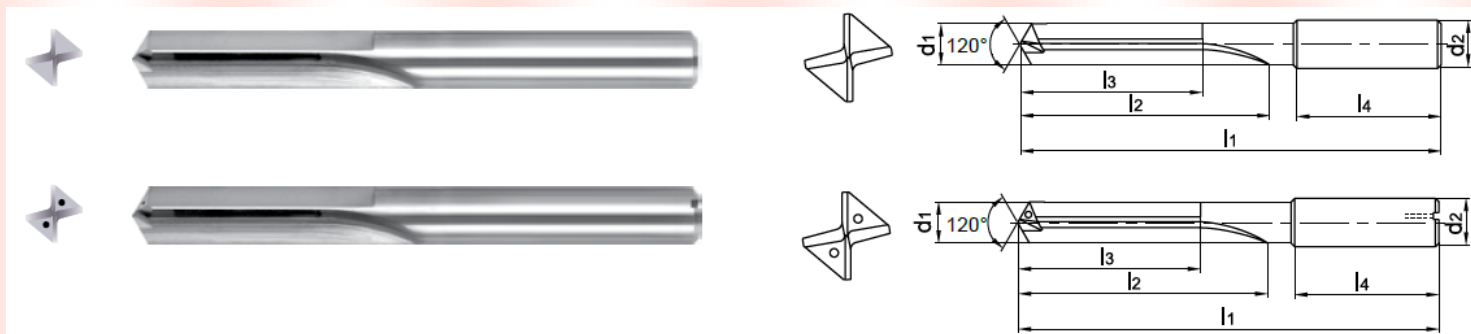

Označení 5xD bez chlazení	Rozměry (mm)					CZK/ks bez DPH
	D1	L3	L2	L1	D2	
AC.5D.PC.040	4	29	36	74	6	445
AC.5D.PC.050	5	35	44	82	6	470
AC.5D.PC.060	6	35	44	82	6	470
AC.5D.PC.0675	6,75	43	53	91	8	470
AC.5D.PC.080	8	43	53	91	8	729
AC.5D.PC.085	8,5	49	61	103	10	729
AC.5D.PC.100	10	49	61	103	10	909
AC.5D.PC.160	16	63	83	133	16	2669

Označení 5xD s chlazením	Rozměry (mm)					CZK/ks bez DPH
	D1	L3	L2	L1	D2	
AC.5D.PC.040 IK	4	29	36	74	6	890
AC.5D.PC.042 IK	4,2	29	36	74	6	890
AC.5D.PC.050 IK	5	35	44	82	6	920
AC.5D.PC.060 IK	6	35	44	82	6	920
AC.5D.PC.0675 IK	6,75	43	53	91	8	1255
AC.5D.PC.080 IK	8	43	53	91	8	1255
AC.5D.PC.085 IK	8,5	49	61	103	10	1585
AC.5D.PC.090 IK	9	49	61	103	10	1585
AC.5D.PC.100 IK	10	49	61	103	10	1585
AC.5D.PC.1025 IK	10,25	56	71	118	12	2199
AC.5D.PC.110 IK	11	56	71	118	12	2199
AC.5D.PC.120 IK	12	56	71	118	12	2199
AC.5D.PC.125 IK	12,5	60	77	124	14	3009
AC.5D.PC.130 IK	13	60	77	124	14	3009
AC.5D.PC.140 IK	14	60	77	124	14	3009
AC.5D.PC.180 IK	18	71	93	143	18	4950
AC.5D.PC.200 IK	20	77	101	153	20	6355

Označení 15xD s chlazením	Rozměry (mm)					CZK/ks bez DPH
	D1	L3	L2	L1	D2	
AC.15D.050 IK	5	96	105	145	6	2090
AC.15D.060 IK	6	96	105	145	6	2090
AC.15D.080 IK	8	127	137	180	8	2939
AC.15D.090 IK	9	158	170	217	10	4320
AC.15D.100 IK	10	158	170	217	10	4320
AC.15D.110 IK	11	190	205	258	12	6055
AC.15D.120 IK	12	190	205	258	12	6055
AC.15D.140 IK	14	219	236	290	14	7530

ALICON s.r.o. Váš partner v třískovém obrábění

Vápenková 547/4, 147 00 Praha 4, IČ: 28179706, DIČ: CZ28179706
Tel: +420774317627, Fax: +420227203615, e-mail: info@alicon.cz, www.alicontool.cz

